



MEASUREMENT REPORT

EN 301 893 V1.8.1 WLAN 802.11a/n

Applicant: Compex Systems Pte Ltd
Address: 135, Joo Seng Road, #08-01 Singapore 368363

Product: 802.11ac Dual Band Module
Model No.: WLE600VX
Brand Name: COMPEX
Standards: ETSI EN 301 893 V1.8.1 (2015-03)
Result: Complies
Test Date: December 28, 2016 ~ January 10, 2017

Reviewed By : Robin Wu
(Robin Wu)

Approved By : Marlin Chen
(Marlin Chen)



The test results relate only to the samples tested.

The test results shown in the test report are traceable to the national/international standards through the calibration of the equipment and evaluated measurement uncertainty herein.

The test report shall not be reproduced except in full without the written approval of MRT Technology (Suzhou) Co., Ltd.

Revision History

Report No.	Version	Description	Issue Date	Note
1612RSU02402	Rev. 01	Initial report	01-14-2017	Valid

CONTENTS

Description	Page
1. General Information.....	5
1.1. Applicant.....	5
1.2. Manufacturer	5
1.3. Testing Facility	5
1.4. Feature of Equipment under Test.....	6
1.5. Product Specification Subjective to this Report.....	6
1.6. Operation Frequency / Channel List	7
1.7. Description of Available Antennas.....	8
1.8. Standards Applicable for Testing.....	8
2. Test Configuration of Equipment under Test.....	9
2.1. Description of Test Mode	9
2.2. Description of Test Software	10
3. Test Summary	11
4. Carrier Frequencies.....	12
4.1. Limit.....	12
4.2. Test Setup	12
4.3. Test Procedure	12
4.4. Test Result.....	13
5. Occupied Channel Bandwidth	14
5.1. Limit.....	14
5.2. Test Setup	14
5.3. Test Procedure	14
5.4. Test Result.....	15
6. RF Output Power, Transmit Power Control (TPC) and Power Density	20
6.1. Limit.....	20
6.2. Test Setup	21
6.3. Test Procedure	21
6.4. Test Result.....	22
7. Transmitter Unwanted Emissions Outside the 5GHz RLAN Bands.....	39
7.1. Limit.....	39
7.2. Test Setup	39
7.3. Test Procedure	40
7.4. Test Result.....	41
8. Transmitter Unwanted Emissions Within the 5GHz RLAN Bands	53
8.1. Limit.....	53

8.2.	Test Setup	53
8.3.	Test Procedure	53
8.4.	Test Result.....	54
9.	Receiver Spurious Emissions.....	71
9.1.	Limit.....	71
9.2.	Test Setup	71
9.3.	Test Procedure	71
9.4.	Test Result.....	72
10.	Adaptivity (Channel Access Mechanism).....	84
10.1.	Limit.....	84
10.2.	Test Setup	84
10.3.	Test Procedure	84
10.4.	Test Result.....	85
11.	User Access Restrictions	87
11.1.	Requirement.....	87
11.2.	Test Result.....	87
12.	Measurement Uncertainty	88
13.	List of Measuring Instrument.....	89

1. General Information

1.1. Applicant

Compex Systems Pte Ltd
135 Joo Seng Road, #08-01 PM Industrial Building Singapore 368363

1.2. Manufacturer

Compex Systems Pte Ltd
135 Joo Seng Road, #08-01 PM Industrial Building Singapore 368363

1.3. Testing Facility

Test Site

MRT Technology (Suzhou) Co., Ltd

Test Site Location

D8 Building, No.2 Tian'edang Rd., Wuzhong Economic Development Zone, Suzhou, China

Test Facility / Accreditations

Measurements were performed at MRT Laboratory located in Tian'edang Rd., Suzhou, China.

- MRT facility is a FCC registered (MRT Reg. No. 809388) test facility with the site description report on file and has met all the requirements specified in Section 2.948 of the FCC Rules.
- MRT facility is an IC registered (MRT Reg. No. 11384A-1) test laboratory with the site description on file at Industry Canada.
- MRT facility is a VCCI registered (R-4179, G-814, C-4664, T-2206) test laboratory with the site description on file at VCCI Council.
- MRT Lab is accredited to ISO 17025 by the American Association for Laboratory Accreditation (A2LA) under the American Association for Laboratory Accreditation Program (A2LA Cert. No. 3628.01) in EMC, Telecommunications and Radio testing for FCC, Industry Canada, EU and TELEC Rules.



1.4. Feature of Equipment under Test

Product Name:	802.11ac Dual Band Module
Model No.:	WLE600VX
Brand Name:	COMPEX
Wi-Fi Specification:	802.11a/b/g/n/ac

Note: Differences between all models are for different marketing requirement.

1.5. Product Specification Subjective to this Report

Frequency Range	802.11a /n-HT20/ac-VHT20: 5180~5240 MHz, 5260~5320 MHz, 5500~5700 MHz; 802.11n-HT40/ac-VHT40: 5190~5230 MHz, 5270~5310 MHz, 5510~5670 MHz; 802.11ac-VHT80: 5210 MHz, 5290 MHz, 5530 MHz, 5610 MHz;
Channel Number	802.11a/n-HT20/ac-VHT20: 19 802.11n-HT40/ac-VHT40: 9 802.11ac-VHT80: 4
Type of Modulation	802.11a/n/ac: OFDM
Data Rate	802.11a: 6/9/12/18/24/36/48/54Mbps 802.11n: up to 300Mbps 802.11ac: up to 866.6Mbps

Note: For other features of this EUT, test report will be issued separately.

1.6. Operation Frequency / Channel List

802.11a/n-HT20/ac-VHT20

Channel	Frequency	Channel	Frequency	Channel	Frequency
36	5180 MHz	40	5200 MHz	44	5220 MHz
48	5240 MHz	52	5260 MHz	56	5280 MHz
60	5300 MHz	64	5320 MHz	100	5500 MHz
104	5520 MHz	108	5540 MHz	112	5560 MHz
116	5580 MHz	120	5600 MHz	124	5620 MHz
128	5640 MHz	132	5660 MHz	136	5680 MHz
140	5700 MHz	--	--	--	--

802.11n-HT40/ac-VHT40

Channel	Frequency	Channel	Frequency	Channel	Frequency
38	5190 MHz	46	5230 MHz	54	5270 MHz
62	5310 MHz	102	5510 MHz	110	5550 MHz
118	5590 MHz	126	5630 MHz	134	5670 MHz

802.11ac-VHT80

Channel	Frequency	Channel	Frequency	Channel	Frequency
42	5210 MHz	58	5290 MHz	106	5530 MHz
122	5610 MHz	N/A	N/A	N/A	N/A

1.7. Description of Available Antennas

Antenna Type	Manufacturer	Tx Paths	Max Directional Gain (dBi)
Dipole Antenna 1#	Kunshan Wavelink Electronic Co., Ltd.	3	2.4GHz: 2.0, 5GHz: 2.0
Dipole Antenna 2#	Smart Ant Inc	3	2.4GHz: 4.5, 5GHz: 7.0
PCB Antenna 3#	TAOGLAS Inc	3	2.4GHz: 4.5, 5GHz: 6.7
PCB Antenna 4#	Compex Systems Pte Ltd	3	2.4GHz: 5.0, 5GHz: 5.0
PCB Antenna 5#	Compex Systems Pte Ltd	3	2.4GHz: 5.0, 5GHz: 5.0

Note: We selected the dipole antenna 2# and PCB antenna 3# for all radiated emission testing.

1.8. Standards Applicable for Testing

The EUT complies with the requirements of ETSI EN 301 893 V1.8.1.

2. Test Configuration of Equipment under Test

2.1. Description of Test Mode

Test Mode	Mode 1: Transmit by 802.11a
	Mode 2: Transmit by 802.11n-HT20
	Mode 3: Transmit by 802.11n-HT40
	Mode 4: Transmit by 802.11ac-VHT20
	Mode 5: Transmit by 802.11ac-VHT40
	Mode 6: Transmit by 802.11ac-VHT80
	Mode 7: Receive by 802.11a
	Mode 8: Receive by 802.11n-HT20
	Mode 9: Receive by 802.11n-HT40
	Mode 10: Receive by 802.11ac-VHT20
	Mode 11: Receive by 802.11ac-VHT40
	Mode 12: Receive by 802.11ac-VHT80

Test Mode	Duty Cycle
11a	96.96%
11n-HT20	94.44%
11n-HT40	85.85%
11ac-VHT20	95.06%
11ac-VHT40	93.54%
11ac-VHT80	80.08%

2.2. Description of Test Software

The test utility software used during testing was “ART2-GUI Version: 2.3” and “CART Version: 4.9”.

Final Power Parameter Value of the test software

Test Mode	Test Frequency	Power Parameter Value		
		Ant 0	Ant 1	Ant 0 + 1
802.11a	5180	14.0	14.5	Not Support
	5320	13.5	14.0	
	5500	20.0	18.5	
	5700	20.0	20.0	
802.11n-HT20	5180	14.0	14.5	11.5
	5320	14.0	14.5	11.5
	5500	20.0	19.0	18.0
	5700	21.0	20.0	20.0
802.11n-HT40	5190	14.5	14.5	13.0
	5310	14.0	15.0	12.5
	5510	20.0	19.0	20.0
	5670	20.0	20.0	20.0
802.11ac-VHT20	5180	14.0	14.5	11.5
	5320	14.0	14.5	11.0
	5500	20.0	19.0	16.0
	5700	20.0	20.0	17.0
802.11ac-VHT40	5190	15.5	15.0	13.0
	5310	15.0	15.5	12.5
	5510	20.0	20.0	20.0
	5670	20.0	20.0	20.0
802.11ac-VHT80	5210	16.0	14.5	13.5
	5290	15.5	15.0	13.0
	5530	20.0	20.0	20.0
	5610	20.0	20.0	20.00

3. Test Summary

Clause EN301893	Test Parameter	Result (Pass/Fail)	Remark
4.2	Carrier Frequencies	Pass	--
4.3	Occupied Channel Bandwidth	Pass	--
4.4	RF Output Power, Transmit Power Control (TPC) and Power Density	Pass	--
4.5.1	Transmitter Unwanted Emissions Outside the 5GHz RLAN Bands	Pass	--
4.5.2	Transmitter Unwanted Emissions Within the 5GHz RLAN Bands	Pass	--
4.6	Receiver Spurious Emissions	Pass	--
4.7	Dynamic Frequency Selection (DFS)	Pass	Refer to DFS report
4.8	Adaptivity	Pass	--
4.9	User Access Restrictions	Pass	--
4.10	Geo-location Capability	N/A	--

Note 1: For Radiated spurious emission test, every axis (X, Y, Z) was also verified. The test results shown in the following sections represent the worst case emissions (Z axis), and the test setup showed in test setup photo.

Note 2: This device doesn't have Geo-location Capability which is declared by the manufacturer.

Note 3: We executed all test items at high data rates, since all modes of operation and data rates have been investigated.

4. Carrier Frequencies

4.1. Limit

The actual centre frequency for any given channel declared by the manufacturer shall be maintained within the range $f_c \pm 20\text{ppm}$.

4.2. Test Setup

For Conducted Measurement

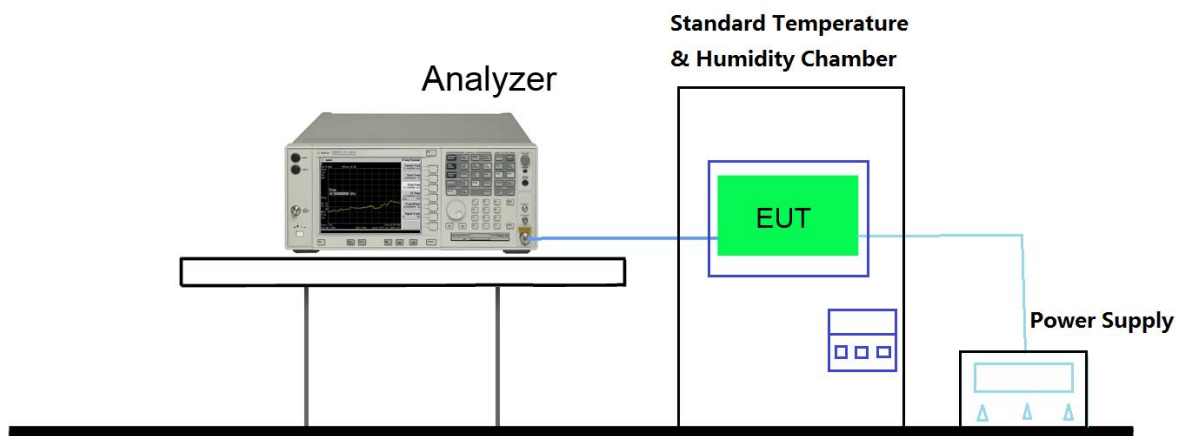

4.3. Test Procedure

Refer to ETSI EN 301 893 V1.8.1 (2015-03) Clause 5.3.2.2.1.

4.4. Test Result

Product	802.11ac Dual Band Module	Temperature	-20 ~ 70°C
Test Engineer	Amy Zhang	Relative Humidity	48 ~ 57%
Test Site	TR3	Test Date	2016/12/29

Test Conditions		Declared Frequency (MHz)	Measured Frequency (MHz)	Tolerance (ppm)	Limit (ppm)	Result
T _{NOM} (25°C)	V _{NOM} (AC 230V)	5320	5319.989845	-1.91	-20 ~ +20	Pass
		5500	5499.988546	-2.08	-20 ~ +20	Pass
T _{MIN} (-20°C)	V _{MIN} (AC 207V)	5320	5319.986945	-2.45	-20 ~ +20	Pass
		5500	5499.988475	-2.10	-20 ~ +20	Pass
	V _{MAX} (AC 253V)	5320	5319.986925	-2.46	-20 ~ +20	Pass
		5500	5499.984857	-2.75	-20 ~ +20	Pass
T _{MAX} (70°C)	V _{MAX} (AC 207V)	5320	5319.988369	-2.19	-20 ~ +20	Pass
		5500	5499.984528	-2.81	-20 ~ +20	Pass
	V _{MAX} (AC 253V)	5320	5319.985691	-2.69	-20 ~ +20	Pass
		5500	5499.986915	-2.38	-20 ~ +20	Pass

Note: Tolerance (ppm) = {Measured Frequency (MHz) - Declared Frequency (MHz)} / Declared Frequency (MHz) * 10⁶ (ppm)

5. Occupied Channel Bandwidth

5.1. Limit

The Nominal Channel Bandwidth shall be at least 5 MHz at all times.

The Occupied Channel Bandwidth shall be between 80 % and 100 % of the declared Nominal Channel Bandwidth. In case of smart antenna systems (devices with multiple transmit Ants) each of the transmit Ants shall meet this requirement.

During an established communication, a device is allowed to operate temporarily with an Occupied Channel Bandwidth below 80 % of its Nominal Channel Bandwidth with a minimum of 4 MHz.

5.2. Test Setup

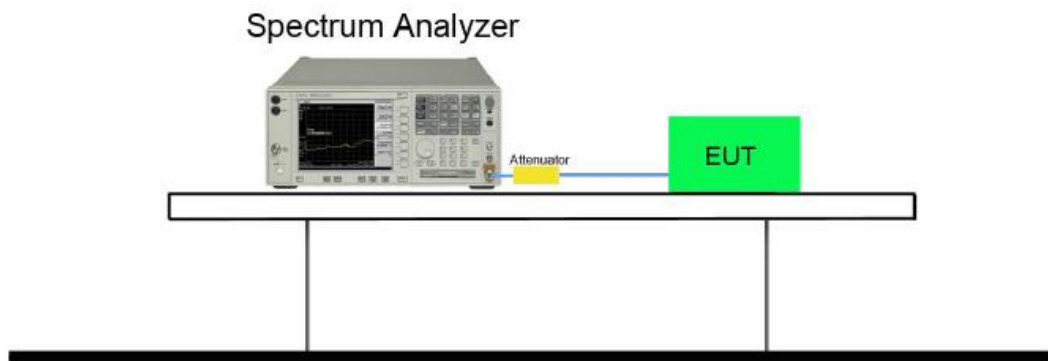

5.3. Test Procedure

Refer to ETSI EN 301 893 V1.8.1 (2015-03) Clause 5.3.3.2.1.

5.4. Test Result

Product	802.11ac Dual Band Module	Temperature	24°C
Test Engineer	Amy Zhang	Relative Humidity	54%
Test Site	TR3	Test Date	2017/01/10

Test Mode	Channel No.	Frequency (MHz)	99% Bandwidth (MHz)	Declared Nominal Channel Bandwidth (MHz)	Occupied Bandwidth (%)	Limit (%)	Result
1Tx							
11a	64	5320	16.43	20	82.15	80 - 100	Pass
11a	100	5500	16.45	20	82.25	80 - 100	Pass
11nHT20	64	5320	17.65	20	88.25	80 - 100	Pass
11n-HT20	100	5500	17.67	20	88.35	80 - 100	Pass
11ac-VHT20	64	5320	17.65	20	88.25	80 - 100	Pass
11ac-VHT20	100	5500	17.66	20	88.30	80 - 100	Pass
11n-HT40	62	5310	36.22	40	90.55	80 - 100	Pass
11n-HT40	102	5510	36.28	40	90.70	80 - 100	Pass
11ac-VHT40	62	5310	36.22	40	90.55	80 - 100	Pass
11ac-VHT40	102	5510	36.28	40	90.70	80 - 100	Pass
11ac-VHT80	42	5210	75.75	80	94.69	80 - 100	Pass
11ac-VHT80	58	5290	75.75	80	94.69	80 - 100	Pass
2Tx							
11nHT20	64	5320	17.65	20	88.25	80 - 100	Pass
11n-HT20	100	5500	17.79	20	88.95	80 - 100	Pass
11ac-VHT20	64	5320	17.65	20	88.25	80 - 100	Pass
11ac-VHT20	100	5500	17.66	20	88.30	80 - 100	Pass
11n-HT40	62	5310	36.22	40	90.55	80 - 100	Pass
11n-HT40	102	5510	36.43	40	91.08	80 - 100	Pass
11ac-VHT40	62	5310	36.23	40	90.58	80 - 100	Pass
11ac-VHT40	102	5510	36.44	40	91.10	80 - 100	Pass
11ac-VHT80	42	5210	75.76	80	94.70	80 - 100	Pass
11ac-VHT80	58	5290	75.99	80	94.99	80 - 100	Pass

Occupied Channel Bandwidth – 1Tx

802.11a

Channel 64 (5320MHz)

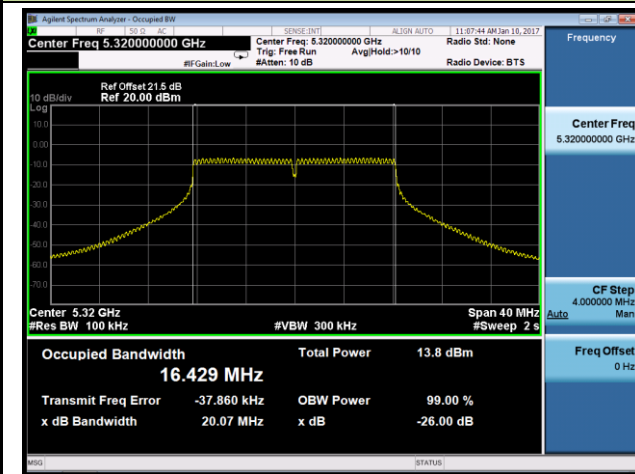

Channel 100 (5500MHz)

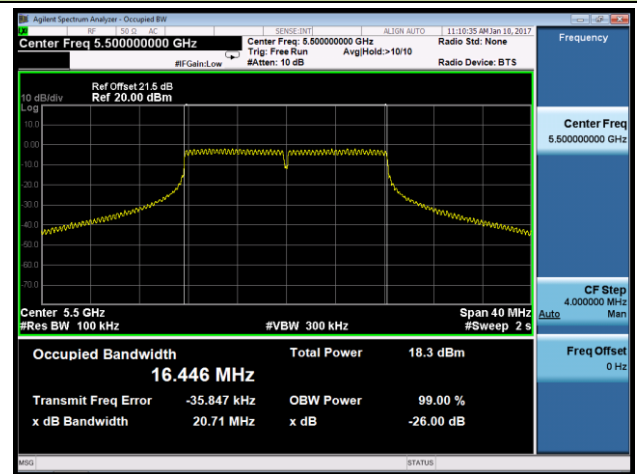

802.11n-HT20

Channel 64 (5320MHz)

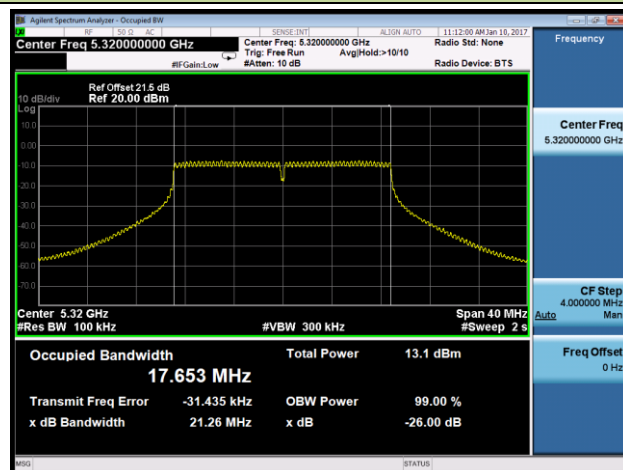

Channel 100 (5500MHz)

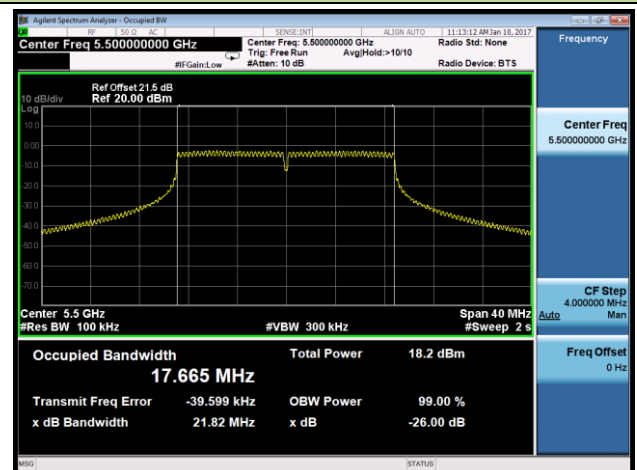

802.11ac-VHT20

Channel 64 (5320MHz)

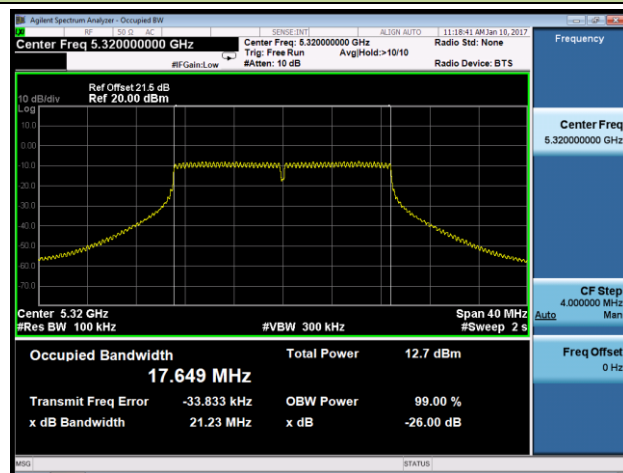

Channel 100 (5500MHz)

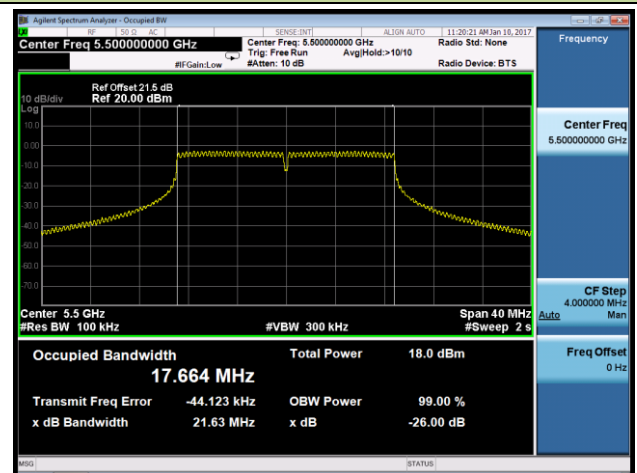

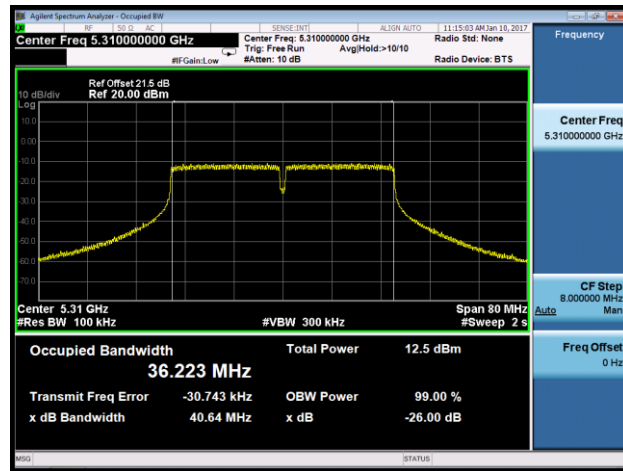
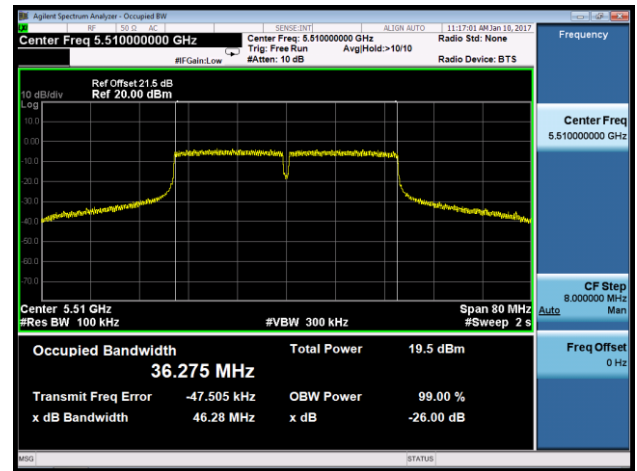
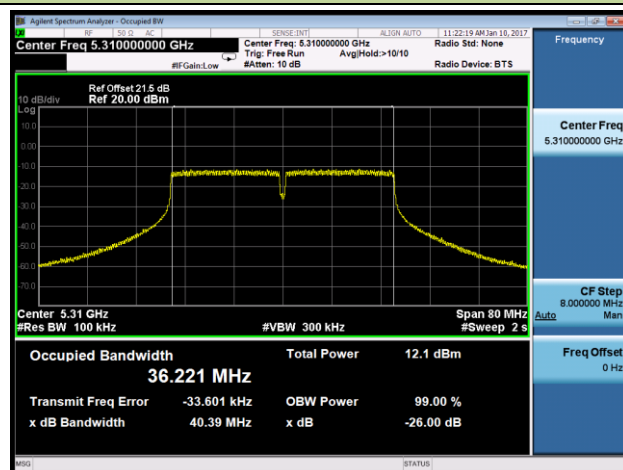
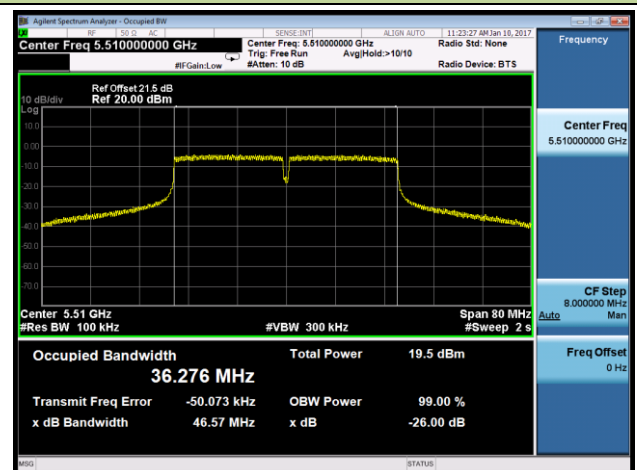
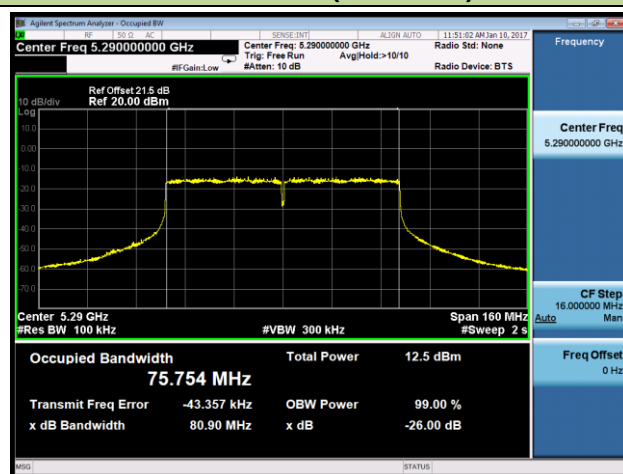
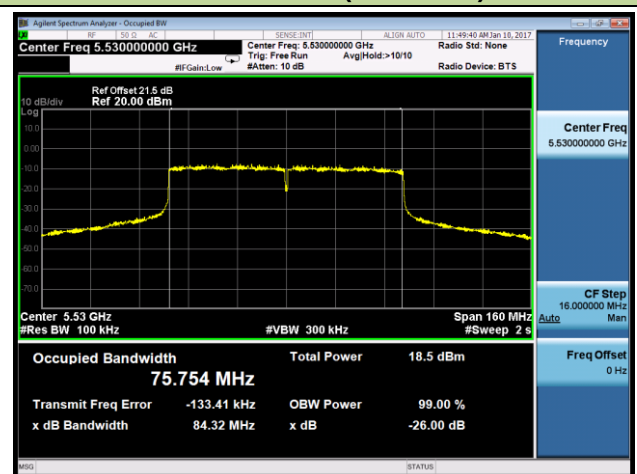
802.11n-HT40
Channel 62 (5310MHz)

Channel 102 (5510MHz)

802.11ac-VHT40
Channel 62 (5310MHz)

Channel 102 (5510MHz)

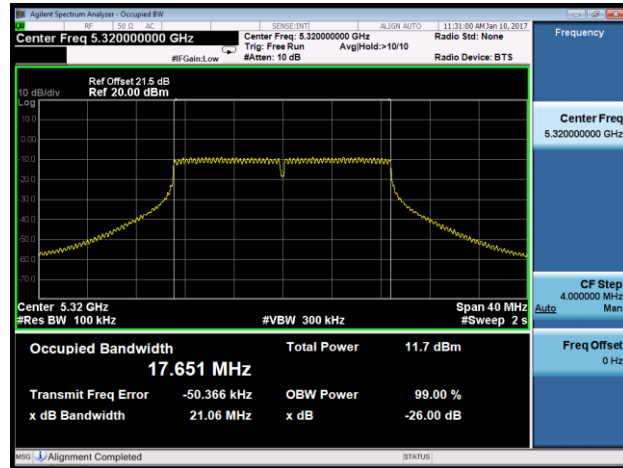
802.11ac-VHT80
Channel 58 (5290MHz)

Channel 106 (5530MHz)

Occupied Channel Bandwidth – 2Tx

802.11n-HT20

Channel 64 (5320MHz)



Channel 100 (5500MHz)

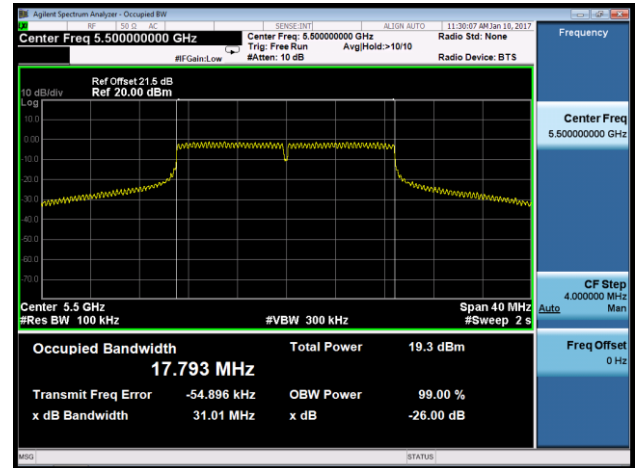

802.11ac-VHT20

Channel 64 (5320MHz)

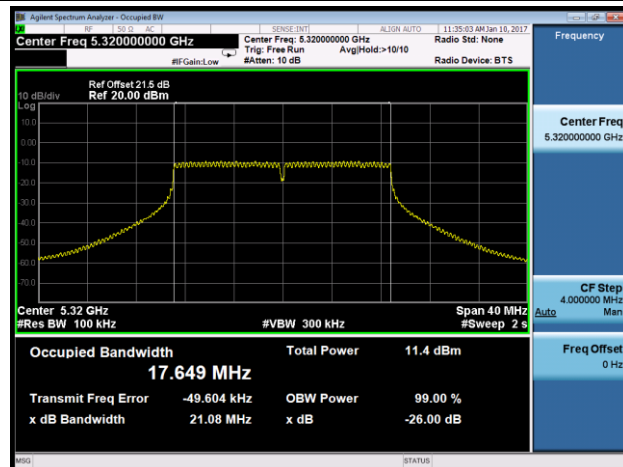

Channel 100 (5500MHz)

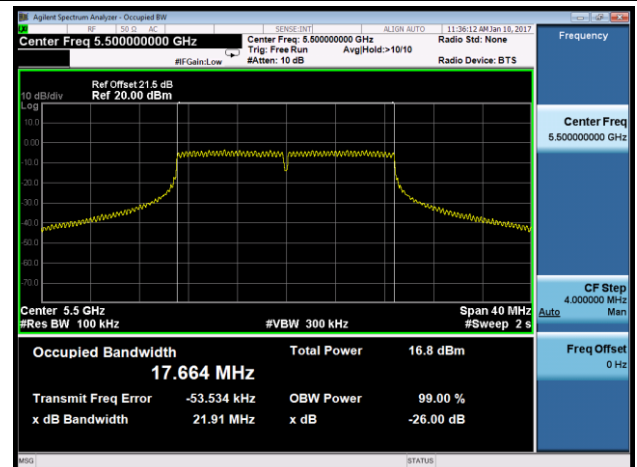

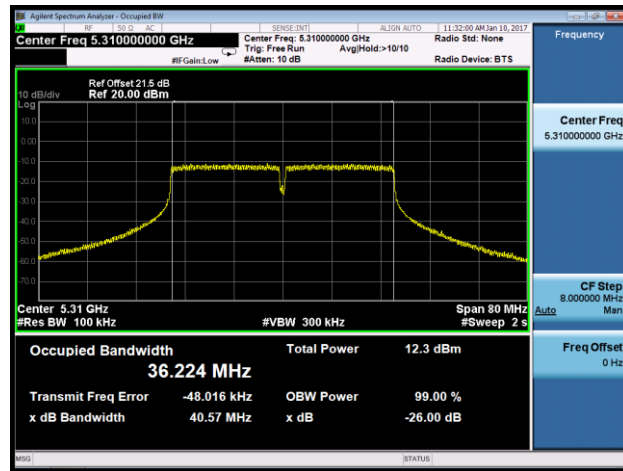
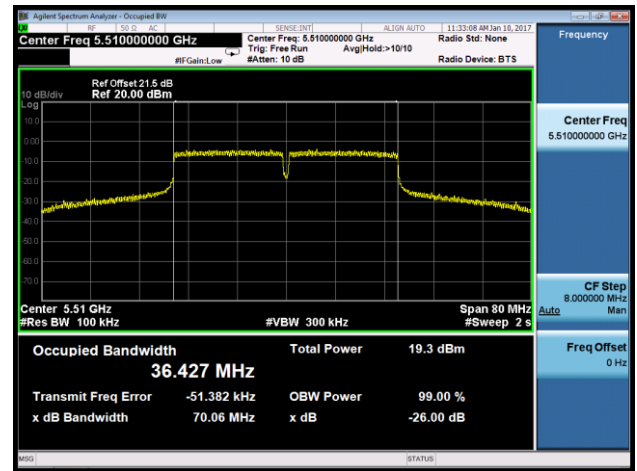
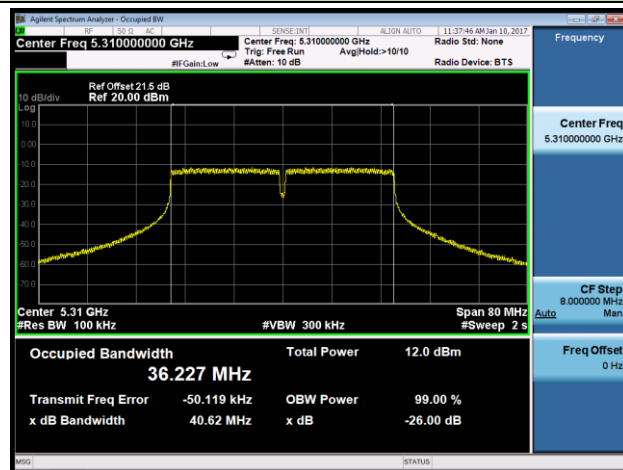
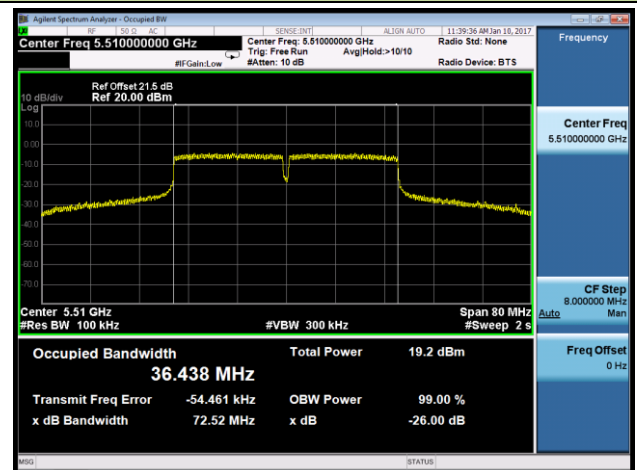
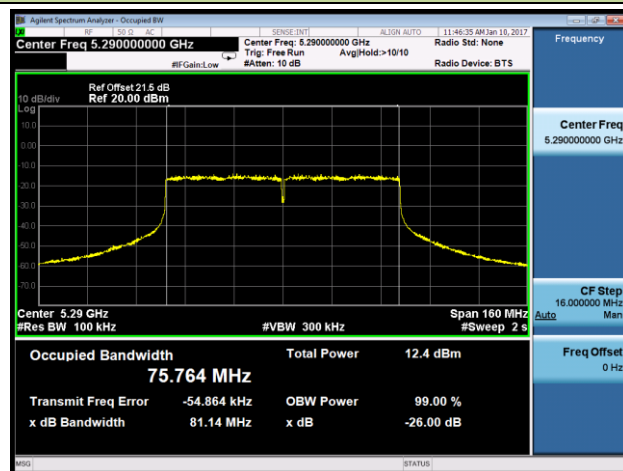
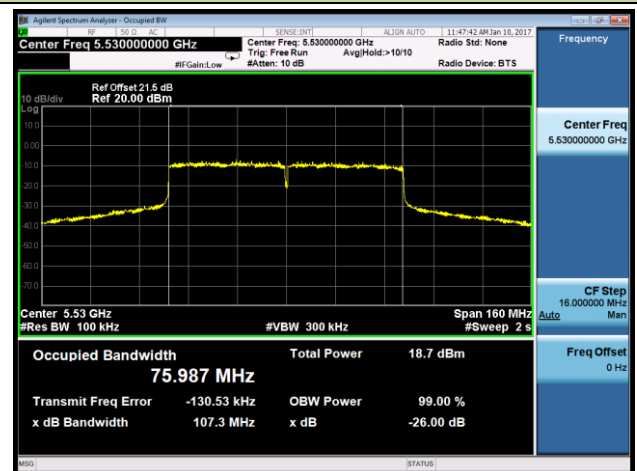
802.11n-HT40
Channel 62 (5310MHz)

Channel 102 (5510MHz)

802.11ac-VHT40
Channel 62 (5310MHz)

Channel 102 (5510MHz)

802.11ac-VHT80
Channel 58 (5290MHz)

Channel 106 (5530MHz)

6. RF Output Power, Transmit Power Control (TPC) and Power Density

6.1. Limit

RF Output Power and Power Density at the Highest Power Level

TPC is not required for channels whose nominal bandwidth falls completely within the band 5150 MHz to 5250 MHz.

For devices with TPC, the RF output power and the power density when configured to operate at the highest stated power level of the TPC range shall not exceed the levels given in following table.

Devices are allowed to operate without TPC. See table for applicable limits in this case.

Mean EIRP limits for RF Output Power and Power Density at the Highest Power Level				
Frequency Range	Mean EIRP Limit [dBm]		Mean EIRP Density Limit [dBm/MHz]	
	with TPC	without TPC	with TPC	without TPC
5150 MHz to 5350 MHz	23	20/23 (see note 1)	10	7/10 (see note 2)
5470 MHz to 5725 MHz	30 (see note 3)	27 (see note 3)	17 (see note 3)	14 (see note 3)

NOTE 1: The applicable limit is 20 dBm, except for transmissions whose nominal bandwidth falls completely within the band 5150 MHz to 5250 MHz, in which case the applicable limit is 23 dBm.

NOTE 2: The applicable limit is 7 dBm/MHz, except for transmissions whose nominal bandwidth falls completely within the band 5150 MHz to 5250 MHz, in which case the applicable limit is 10 dBm/MHz.

NOTE 3: Slave devices without a Radar Interference Detection function shall comply with the limits for the band 5250 MHz to 5350 MHz.

RF Output Power at the Lowest Power Level of the TPC Range

For devices using TPC, the RF output power during a transmission burst when configured to operate at the lowest stated power level of the TPC range shall not exceed the levels given in following table.

For devices without TPC, the limits in table do not apply.

Mean EIRP Limits for RF Output Power at the Lowest Power Level of the TPC Range	
Frequency Range	Mean EIRP [dBm]
5250 MHz to 5350 MHz	17
5470 MHz to 5725 MHz	24 (see note)

Note: Slave devices without a Radar Interference Detection function shall comply with the limits for the band 5250 MHz to 5350 MHz.

6.2. Test Setup

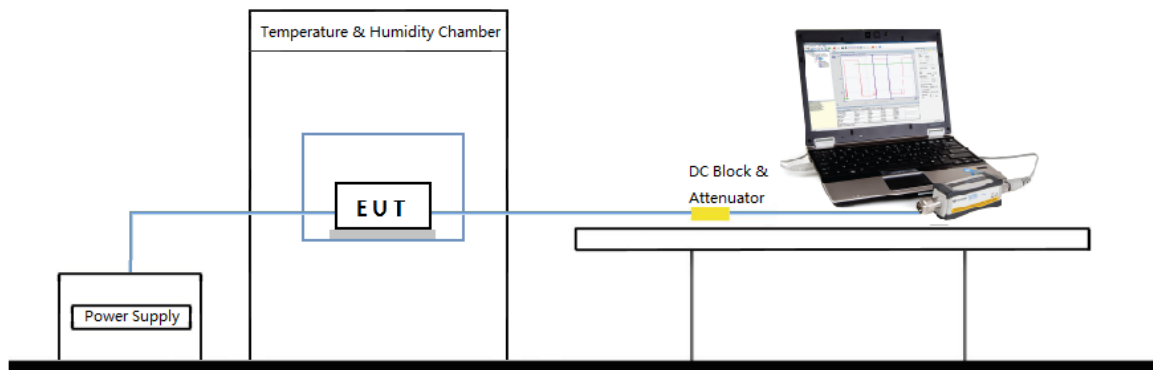

6.3. Test Procedure

Refer to ETSI EN 301 893 V1.8.1 (2015-03) Clause 5.3.4.2.1.

6.4. Test Result

Product	802.11ac Dual Band Module	Temperature	-20 ~ 70°C
Test Engineer	Amy Zhang	Relative Humidity	50 ~ 58%
Test Site	TR3	Test Date	2017/01/02
Test Item	RF Output Power		

Normal Conditions (Temperature 25°C)

1Tx

Mode	Ch. No.	Freq. (MHz)	RF Output Power (dBm)		Max EIRP Power (dBm)	Limit (dBm)	Result
			Ant 0	Ant 1			
11a	36	5180	14.62	14.03	21.75	23	Pass
11a	64	5320	14.42	14.11	21.55	23	Pass
11a	100	5500	18.62	18.61	25.75	30	Pass
11a	140	5700	18.44	18.52	25.65	30	Pass
11n-HT20	36	5180	14.62	14.15	21.87	23	Pass
11n-HT20	64	5320	14.29	14.71	21.96	23	Pass
11n-HT20	100	5500	18.62	18.76	26.01	30	Pass
11n-HT20	140	5700	17.82	18.42	25.67	30	Pass
11ac-VHT20	36	5180	14.53	14.03	22.19	23	Pass
11ac-VHT20	64	5320	14.62	14.25	22.28	23	Pass
11ac-VHT20	100	5500	18.42	18.69	26.35	30	Pass
11ac-VHT20	140	5700	18.62	18.41	26.28	30	Pass
11n-HT40	38	5190	14.36	14.03	21.58	23	Pass
11n-HT40	62	5310	14.36	14.29	21.58	23	Pass
11n-HT40	102	5510	18.52	18.76	25.98	30	Pass
11n-HT40	134	5670	18.62	18.54	25.84	30	Pass
11ac-VHT40	38	5190	14.62	13.36	21.91	23	Pass
11ac-VHT40	62	5310	14.69	14.52	21.98	23	Pass
11ac-VHT40	102	5510	18.62	18.46	25.91	30	Pass
11ac-VHT40	134	5670	18.52	18.41	25.81	30	Pass
11ac-VHT80	42	5210	14.62	14.32	22.58	23	Pass
11ac-VHT80	58	5290	14.29	13.62	22.25	23	Pass
11ac-VHT80	106	5530	18.63	18.46	26.59	30	Pass
11ac-VHT80	122	5610	18.49	18.84	26.80	30	Pass

Note: EIRP Power (dBm) = RF Output Power (dBm) + Antenna Gain (dBi) + 10*Log(1/Duty Cycle).

2Tx

Mode	Ch. No.	Freq. (MHz)	RF Output Power (dBm)		Total EIRP Power (dBm)	Limit (dBm)	Result
			Ant 0	Ant 1			
11n-HT20	36	5180	11.36	11.25	21.56	23	Pass
11n-HT20	64	5320	11.54	11.35	21.70	23	Pass
11n-HT20	100	5500	18.24	18.78	28.78	30	Pass
11n-HT20	140	5700	18.66	18.81	28.99	30	Pass
11ac-VHT20	36	5180	12.15	11.64	22.58	23	Pass
11ac-VHT20	64	5320	11.86	11.74	22.47	23	Pass
11ac-VHT20	100	5500	18.26	18.68	29.15	30	Pass
11ac-VHT20	140	5700	18.26	18.26	28.93	30	Pass
11n-HT40	38	5190	11.26	11.63	21.68	23	Pass
11n-HT40	62	5310	11.64	11.42	21.76	23	Pass
11n-HT40	102	5510	18.64	18.59	28.85	30	Pass
11n-HT40	134	5670	18.49	18.48	28.72	30	Pass
11ac-VHT40	38	5190	12.03	11.56	22.10	23	Pass
11ac-VHT40	62	5310	11.84	11.54	21.99	23	Pass
11ac-VHT40	102	5510	18.68	18.24	28.77	30	Pass
11ac-VHT40	134	5670	18.42	18.56	28.79	30	Pass
11ac-VHT80	42	5210	11.92	11.63	22.75	23	Pass
11ac-VHT80	58	5290	11.46	11.2	22.31	23	Pass
11ac-VHT80	106	5530	18.46	18.39	29.40	30	Pass
11ac-VHT80	122	5610	18.55	18.49	29.50	30	Pass

Note: Total EIRP Power(dBm) = $10 \cdot \log\{10^{(\text{Ant 0 RF Output Power}/10)} + 10^{(\text{Ant 1 RF Output Power}/10)}\} + \text{Antenna Gain(dBi)} + 10 \cdot \log(1/\text{Duty Cycle})$.

Extreme Conditions (Temperature -20°C / AC 207V)

1Tx

Mode	Ch. No.	Freq. (MHz)	RF Output Power (dBm)		Max EIRP Power (dBm)	Limit (dBm)	Result
			Ant 0	Ant 1			
11a	36	5180	13.54	12.88	20.67	23	Pass
11a	64	5320	13.41	13.24	20.54	23	Pass
11a	100	5500	17.64	17.35	24.77	30	Pass
11a	140	5700	17.29	17.41	24.54	30	Pass
11n-HT20	36	5180	13.46	13.29	20.71	23	Pass
11n-HT20	64	5320	13.29	13.28	20.54	23	Pass
11n-HT20	100	5500	18.22	17.66	25.47	30	Pass
11n-HT20	140	5700	17.74	17.41	24.99	30	Pass
11ac-VHT20	36	5180	13.46	13.82	21.48	23	Pass
11ac-VHT20	64	5320	13.66	14.94	22.60	23	Pass
11ac-VHT20	100	5500	16.82	17.49	25.15	30	Pass
11ac-VHT20	140	5700	17.55	18.03	25.69	30	Pass
11n-HT40	38	5190	13.44	14.62	21.84	23	Pass
11n-HT40	62	5310	13.55	13.21	20.77	23	Pass
11n-HT40	102	5510	17.68	17.42	24.90	30	Pass
11n-HT40	134	5670	17.48	17.86	25.08	30	Pass
11ac-VHT40	38	5190	13.55	13.29	20.84	23	Pass
11ac-VHT40	62	5310	13.49	12.66	20.78	23	Pass
11ac-VHT40	102	5510	17.52	17.68	24.97	30	Pass
11ac-VHT40	134	5670	17.29	17.69	24.98	30	Pass
11ac-VHT80	42	5210	13.55	13.46	21.51	23	Pass
11ac-VHT80	58	5290	13.49	13.21	21.45	23	Pass
11ac-VHT80	106	5530	17.61	17.49	25.57	30	Pass
11ac-VHT80	122	5610	17.58	17.49	25.54	30	Pass

Note: EIRP Power (dBm) = RF Output Power (dBm) + Antenna Gain (dBi) + 10*Log(1/Duty Cycle).

2Tx

Mode	Ch. No.	Freq. (MHz)	RF Output Power (dBm)		Total EIRP Power (dBm)	Limit (dBm)	Result
			Ant 0	Ant 1			
11n-HT20	36	5180	10.42	10.31	20.62	23	Pass
11n-HT20	64	5320	10.66	10.25	20.72	23	Pass
11n-HT20	100	5500	17.24	17.85	27.81	30	Pass
11n-HT20	140	5700	17.49	17.59	27.80	30	Pass
11ac-VHT20	36	5180	10.99	10.64	21.49	23	Pass
11ac-VHT20	64	5320	10.84	10.51	21.35	23	Pass
11ac-VHT20	100	5500	17.19	17.69	28.12	30	Pass
11ac-VHT20	140	5700	17.46	17.58	28.19	30	Pass
11n-HT40	38	5190	10.25	10.68	20.70	23	Pass
11n-HT40	62	5310	10.69	10.49	20.82	23	Pass
11n-HT40	102	5510	17.64	17.55	27.83	30	Pass
11n-HT40	134	5670	17.49	17.63	27.79	30	Pass
11ac-VHT40	38	5190	11.24	10.62	21.24	23	Pass
11ac-VHT40	62	5310	10.49	10.53	20.81	23	Pass
11ac-VHT40	102	5510	17.69	17.33	27.81	30	Pass
11ac-VHT40	134	5670	17.36	17.91	27.94	30	Pass
11ac-VHT80	42	5210	10.94	10.66	21.78	23	Pass
11ac-VHT80	58	5290	10.69	10.24	21.45	23	Pass
11ac-VHT80	106	5530	17.81	17.48	28.62	30	Pass
11ac-VHT80	122	5610	17.59	17.68	28.61	30	Pass

Note: Total EIRP Power(dBm) = $10 \cdot \log\{10^{(\text{Ant 0 RF Output Power}/10)} + 10^{(\text{Ant 1 RF Output Power}/10)}\} + \text{Antenna Gain(dBi)} + 10 \cdot \log(1/\text{Duty Cycle})$.

Extreme Conditions (Temperature -20°C / AC 253V)

1Tx

Mode	Ch. No.	Freq. (MHz)	RF Output Power (dBm)		Max EIRP Power (dBm)	Limit (dBm)	Result
			Ant 0	Ant 1			
11a	36	5180	13.48	12.91	20.61	23	Pass
11a	64	5320	13.29	13.25	20.42	23	Pass
11a	100	5500	17.59	17.24	24.72	30	Pass
11a	140	5700	17.19	17.34	24.47	30	Pass
11n-HT20	36	5180	13.52	13.27	20.77	23	Pass
11n-HT20	64	5320	13.51	13.42	20.76	23	Pass
11n-HT20	100	5500	18.11	17.49	25.36	30	Pass
11n-HT20	140	5700	17.81	17.62	25.06	30	Pass
11ac-VHT20	36	5180	13.52	13.95	21.61	23	Pass
11ac-VHT20	64	5320	13.78	14.68	22.34	23	Pass
11ac-VHT20	100	5500	16.59	17.81	25.47	30	Pass
11ac-VHT20	140	5700	17.49	17.86	25.52	30	Pass
11n-HT40	38	5190	13.64	14.59	21.81	23	Pass
11n-HT40	62	5310	13.69	13.48	20.91	23	Pass
11n-HT40	102	5510	17.81	17.29	25.03	30	Pass
11n-HT40	134	5670	17.59	17.88	25.10	30	Pass
11ac-VHT40	38	5190	13.69	13.51	20.98	23	Pass
11ac-VHT40	62	5310	13.59	12.94	20.88	23	Pass
11ac-VHT40	102	5510	17.49	17.48	24.78	30	Pass
11ac-VHT40	134	5670	17.49	17.59	24.88	30	Pass
11ac-VHT80	42	5210	13.36	13.55	21.51	23	Pass
11ac-VHT80	58	5290	13.29	13.42	21.38	23	Pass
11ac-VHT80	106	5530	17.49	17.23	25.45	30	Pass
11ac-VHT80	122	5610	17.78	17.68	25.74	30	Pass

Note: EIRP Power (dBm) = RF Output Power (dBm) + Antenna Gain (dBi) + 10*Log(1/Duty Cycle).

2Tx

Mode	Ch. No.	Freq. (MHz)	RF Output Power (dBm)		Total EIRP Power (dBm)	Limit (dBm)	Result
			Ant 0	Ant 1			
11n-HT20	36	5180	10.55	10.39	20.73	23	Pass
11n-HT20	64	5320	10.58	10.42	20.76	23	Pass
11n-HT20	100	5500	17.55	17.49	27.78	30	Pass
11n-HT20	140	5700	17.69	17.48	27.85	30	Pass
11ac-VHT20	36	5180	11.24	10.84	21.72	23	Pass
11ac-VHT20	64	5320	10.94	10.66	21.48	23	Pass
11ac-VHT20	100	5500	17.28	17.71	28.17	30	Pass
11ac-VHT20	140	5700	17.68	17.49	28.26	30	Pass
11n-HT40	38	5190	10.39	10.59	20.72	23	Pass
11n-HT40	62	5310	10.72	10.61	20.90	23	Pass
11n-HT40	102	5510	17.59	17.42	27.74	30	Pass
11n-HT40	134	5670	17.24	17.35	27.53	30	Pass
11ac-VHT40	38	5190	11.39	10.82	21.41	23	Pass
11ac-VHT40	62	5310	10.62	10.73	20.98	23	Pass
11ac-VHT40	102	5510	17.81	17.29	27.86	30	Pass
11ac-VHT40	134	5670	17.42	17.81	27.92	30	Pass
11ac-VHT80	42	5210	10.99	10.53	21.74	23	Pass
11ac-VHT80	58	5290	10.71	10.35	21.51	23	Pass
11ac-VHT80	106	5530	17.91	17.51	28.69	30	Pass
11ac-VHT80	122	5610	17.91	17.66	28.76	30	Pass

Note: Total EIRP Power(dBm) = $10 \cdot \log\{10^{(\text{Ant 0 RF Output Power}/10)} + 10^{(\text{Ant 1 RF Output Power}/10)}\} + \text{Antenna Gain(dBi)} + 10 \cdot \log(1/\text{Duty Cycle})$.

Extreme Conditions (Temperature 70°C / AC 207V)

1Tx

Mode	Ch. No.	Freq. (MHz)	RF Output Power (dBm)		Max EIRP Power (dBm)	Limit (dBm)	Result
			Ant 0	Ant 1			
11a	36	5180	15.61	14.82	22.74	23	Pass
11a	64	5320	15.68	15.48	22.81	23	Pass
11a	100	5500	19.28	19.58	26.71	30	Pass
11a	140	5700	19.42	19.62	26.75	30	Pass
11n-HT20	36	5180	15.48	15.29	22.73	23	Pass
11n-HT20	64	5320	15.39	15.49	22.74	23	Pass
11n-HT20	100	5500	19.52	19.49	26.77	30	Pass
11n-HT20	140	5700	19.55	19.61	26.86	30	Pass
11ac-VHT20	36	5180	14.84	14.29	22.50	23	Pass
11ac-VHT20	64	5320	14.42	15.24	22.90	23	Pass
11ac-VHT20	100	5500	19.26	19.46	27.12	30	Pass
11ac-VHT20	140	5700	19.46	19.24	27.12	30	Pass
11n-HT40	38	5190	15.32	14.33	22.54	23	Pass
11n-HT40	62	5310	15.35	15.35	22.57	23	Pass
11n-HT40	102	5510	19.26	19.74	26.96	30	Pass
11n-HT40	134	5670	19.68	19.46	26.90	30	Pass
11ac-VHT40	38	5190	15.59	14.64	22.88	23	Pass
11ac-VHT40	62	5310	15.62	15.48	22.91	23	Pass
11ac-VHT40	102	5510	19.48	19.28	26.77	30	Pass
11ac-VHT40	134	5670	19.24	19.20	26.53	30	Pass
11ac-VHT80	42	5210	14.41	14.86	22.82	23	Pass
11ac-VHT80	58	5290	14.26	13.85	22.22	23	Pass
11ac-VHT80	106	5530	19.24	19.34	27.30	30	Pass
11ac-VHT80	122	5610	19.22	19.24	27.20	30	Pass

Note: EIRP Power (dBm) = RF Output Power (dBm) + Antenna Gain (dBi) + 10*Log(1/Duty Cycle).

2Tx

Mode	Ch. No.	Freq. (MHz)	RF Output Power (dBm)		Total EIRP Power (dBm)	Limit (dBm)	Result
			Ant 0	Ant 1			
11n-HT20	36	5180	12.34	12.06	22.46	23	Pass
11n-HT20	64	5320	12.19	12.24	22.47	23	Pass
11n-HT20	100	5500	19.52	19.61	29.82	30	Pass
11n-HT20	140	5700	19.46	19.49	29.73	30	Pass
11ac-VHT20	36	5180	11.64	11.58	22.28	23	Pass
11ac-VHT20	64	5320	11.91	11.55	22.41	23	Pass
11ac-VHT20	100	5500	19.24	19.03	29.81	30	Pass
11ac-VHT20	140	5700	19.11	19.24	29.85	30	Pass
11n-HT40	38	5190	12.62	11.86	22.49	23	Pass
11n-HT40	62	5310	12.35	12.22	22.52	23	Pass
11n-HT40	102	5510	19.33	19.24	29.52	30	Pass
11n-HT40	134	5670	19.28	19.26	29.50	30	Pass
11ac-VHT40	38	5190	12.77	12.19	22.79	23	Pass
11ac-VHT40	62	5310	12.51	12.26	22.69	23	Pass
11ac-VHT40	102	5510	19.29	19.24	29.57	30	Pass
11ac-VHT40	134	5670	19.24	19.55	29.70	30	Pass
11ac-VHT80	42	5210	11.81	11.29	22.53	23	Pass
11ac-VHT80	58	5290	11.59	11.77	22.66	23	Pass
11ac-VHT80	106	5530	18.62	18.49	29.53	30	Pass
11ac-VHT80	122	5610	18.42	18.61	29.49	30	Pass

Note: Total EIRP Power(dBm) = $10 \cdot \log\{10^{(\text{Ant 0 RF Output Power}/10)} + 10^{(\text{Ant 1 RF Output Power}/10)}\} + \text{Antenna Gain(dBi)} + 10 \cdot \log(1/\text{Duty Cycle})$.

Extreme Conditions (Temperature 70°C / AC 253V)

1Tx

Mode	Ch. No.	Freq. (MHz)	RF Output Power (dBm)		Max EIRP Power (dBm)	Limit (dBm)	Result
			Ant 0	Ant 1			
11a	36	5180	15.48	14.77	22.61	23	Pass
11a	64	5320	15.49	15.39	22.62	23	Pass
11a	100	5500	19.33	19.46	26.59	30	Pass
11a	140	5700	19.46	19.55	26.68	30	Pass
11n-HT20	36	5180	15.35	15.36	22.61	23	Pass
11n-HT20	64	5320	15.59	15.41	22.84	23	Pass
11n-HT20	100	5500	19.36	19.29	26.61	30	Pass
11n-HT20	140	5700	19.46	19.54	26.79	30	Pass
11ac-VHT20	36	5180	14.75	14.39	22.41	23	Pass
11ac-VHT20	64	5320	14.29	15.24	22.90	23	Pass
11ac-VHT20	100	5500	19.22	19.61	27.27	30	Pass
11ac-VHT20	140	5700	19.55	19.35	27.21	30	Pass
11n-HT40	38	5190	15.29	14.85	22.51	23	Pass
11n-HT40	62	5310	15.64	15.46	22.86	23	Pass
11n-HT40	102	5510	19.33	19.64	26.86	30	Pass
11n-HT40	134	5670	19.28	19.44	26.66	30	Pass
11ac-VHT40	38	5190	15.36	14.55	22.65	23	Pass
11ac-VHT40	62	5310	15.29	15.28	22.58	23	Pass
11ac-VHT40	102	5510	19.26	19.66	26.95	30	Pass
11ac-VHT40	134	5670	19.33	19.24	26.62	30	Pass
11ac-VHT80	42	5210	14.22	14.81	22.77	23	Pass
11ac-VHT80	58	5290	14.14	13.77	22.10	23	Pass
11ac-VHT80	106	5530	19.06	19.13	27.09	30	Pass
11ac-VHT80	122	5610	19.03	19.61	27.57	30	Pass

Note: EIRP Power (dBm) = RF Output Power (dBm) + Antenna Gain (dBi) + 10*Log(1/Duty Cycle).

2Tx

Mode	Ch. No.	Freq. (MHz)	RF Output Power (dBm)		Total EIRP Power (dBm)	Limit (dBm)	Result
			Ant 0	Ant 1			
11n-HT20	36	5180	12.24	11.95	22.36	23	Pass
11n-HT20	64	5320	12.03	12.21	22.38	23	Pass
11n-HT20	100	5500	19.32	19.48	29.66	30	Pass
11n-HT20	140	5700	19.42	19.64	29.79	30	Pass
11ac-VHT20	36	5180	11.84	11.63	22.41	23	Pass
11ac-VHT20	64	5320	11.82	11.64	22.40	23	Pass
11ac-VHT20	100	5500	19.33	19.14	29.91	30	Pass
11ac-VHT20	140	5700	19.03	19.33	29.86	30	Pass
11n-HT40	38	5190	12.42	11.66	22.29	23	Pass
11n-HT40	62	5310	12.21	12.03	22.35	23	Pass
11n-HT40	102	5510	19.28	19.35	29.55	30	Pass
11n-HT40	134	5670	19.31	19.36	29.57	30	Pass
11ac-VHT40	38	5190	12.55	12.31	22.73	23	Pass
11ac-VHT40	62	5310	12.49	12.48	22.79	23	Pass
11ac-VHT40	102	5510	19.05	19.34	29.50	30	Pass
11ac-VHT40	134	5670	19.03	19.48	29.56	30	Pass
11ac-VHT80	42	5210	11.74	11.05	22.38	23	Pass
11ac-VHT80	58	5290	11.42	11.64	22.51	23	Pass
11ac-VHT80	106	5530	18.43	18.35	29.37	30	Pass
11ac-VHT80	122	5610	18.36	18.43	29.37	30	Pass

Note: Total EIRP Power(dBm) = $10 \cdot \log\{10^{(\text{Ant 0 RF Output Power}/10)} + 10^{(\text{Ant 1 RF Output Power}/10)}\} + \text{Antenna Gain(dBi)} + 10 \cdot \log(1/\text{Duty Cycle})$.

Product	802.11ac Dual Band Module	Temperature	-20 ~ 70°C
Test Engineer	Amy Zhang	Relative Humidity	50 ~ 58%
Test Site	TR3	Test Date	2017/01/02
Test Item	Transmit Power Control (TPC)		

Normal Conditions (Temperature 25°C)

Mode	Ch. No.	Freq. (MHz)	RF Output Power (dBm)		Total EIRP Power (dBm)	Limit (dBm)	Result
			Ant 0	Ant 1			
11n-HT20	64	5320	2.11	1.65	12.14	17	Pass
11n-HT20	100	5500	10.84	11.26	21.31	24	Pass
11n-HT20	140	5700	10.21	10.35	20.54	24	Pass
11ac-VHT20	64	5320	3.03	2.64	13.51	17	Pass
11ac-VHT20	100	5500	10.84	11.25	21.72	24	Pass
11ac-VHT20	140	5700	9.85	10.68	20.96	24	Pass
11n-HT40	62	5310	2.68	2.69	12.92	17	Pass
11n-HT40	102	5510	10.81	10.59	20.93	24	Pass
11n-HT40	134	5670	10.68	10.59	20.87	24	Pass
11ac-VHT40	62	5310	2.81	2.61	13.01	17	Pass
11ac-VHT40	102	5510	11.16	10.69	21.23	24	Pass
11ac-VHT40	134	5670	9.76	9.82	20.09	24	Pass
11ac-VHT80	58	5290	2.64	2.21	13.41	17	Pass
11ac-VHT80	106	5530	10.58	10.66	21.60	24	Pass
11ac-VHT80	122	5610	10.15	10.36	21.23	24	Pass

Note: Total EIRP Power(dBm) = $10 \cdot \log\{10^{(\text{Ant 0 RF Output Power} / 10)} + 10^{(\text{Ant 1 RF Output Power} / 10)} + 10^{(\text{Ant 2 RF Output Power} / 10)}\} + \text{Antenna Gain(dBi)} + 10 \cdot \log(1/\text{Duty Cycle})$

Extreme Conditions (Temperature -20°C / AC 207V)

Mode	Ch. No.	Freq. (MHz)	RF Output Power (dBm)		Total EIRP Power (dBm)	Limit (dBm)	Result
			Ant 0	Ant 1			
11n-HT20	64	5320	1.15	0.84	11.26	17	Pass
11n-HT20	100	5500	9.69	10.36	20.30	24	Pass
11n-HT20	140	5700	8.99	9.38	19.45	24	Pass
11ac-VHT20	64	5320	1.88	1.49	12.36	17	Pass
11ac-VHT20	100	5500	9.64	9.86	20.42	24	Pass
11ac-VHT20	140	5700	8.74	9.48	19.80	24	Pass
11n-HT40	62	5310	1.66	1.81	11.97	17	Pass
11n-HT40	102	5510	9.46	9.48	19.70	24	Pass
11n-HT40	134	5670	9.64	9.44	19.77	24	Pass
11ac-VHT40	62	5310	1.87	1.85	12.16	17	Pass
11ac-VHT40	102	5510	9.76	9.46	19.91	24	Pass
11ac-VHT40	134	5670	8.61	8.47	18.84	24	Pass
11ac-VHT80	58	5290	1.66	1.24	12.43	17	Pass
11ac-VHT80	106	5530	9.48	9.78	20.61	24	Pass
11ac-VHT80	122	5610	9.25	9.36	20.28	24	Pass

Note: Total EIRP Power(dBm) = $10 \cdot \log\{10^{(\text{Ant 0 RF Output Power} / 10)} + 10^{(\text{Ant 1 RF Output Power} / 10)} + 10^{(\text{Ant 2 RF Output Power} / 10)}\} + \text{Antenna Gain(dBi)} + 10 \cdot \log(1/\text{Duty Cycle})$

Extreme Conditions (Temperature -20°C / AC 253V)

Mode	Ch. No.	Freq. (MHz)	RF Output Power (dBm)		Total EIRP Power (dBm)	Limit (dBm)	Result
			Ant 0	Ant 1			
11n-HT20	64	5320	1.26	0.99	11.39	17	Pass
11n-HT20	100	5500	9.85	10.54	20.47	24	Pass
11n-HT20	140	5700	8.79	9.41	19.37	24	Pass
11ac-VHT20	64	5320	1.92	1.52	12.40	17	Pass
11ac-VHT20	100	5500	9.84	10.11	20.65	24	Pass
11ac-VHT20	140	5700	8.89	9.69	19.98	24	Pass
11n-HT40	62	5310	1.55	1.63	11.82	17	Pass
11n-HT40	102	5510	9.28	9.35	19.55	24	Pass
11n-HT40	134	5670	9.81	9.46	19.87	24	Pass
11ac-VHT40	62	5310	1.64	1.92	12.08	17	Pass
11ac-VHT40	102	5510	9.86	9.68	20.07	24	Pass
11ac-VHT40	134	5670	8.82	8.59	19.01	24	Pass
11ac-VHT80	58	5290	1.76	1.43	12.57	17	Pass
11ac-VHT80	106	5530	9.58	9.82	20.68	24	Pass
11ac-VHT80	122	5610	9.38	9.47	20.40	24	Pass

Note: Total EIRP Power(dBm) = $10 \cdot \log\{10^{(\text{Ant 0 RF Output Power} / 10)} + 10^{(\text{Ant 1 RF Output Power} / 10)} + 10^{(\text{Ant 2 RF Output Power} / 10)}\} + \text{Antenna Gain(dBi)} + 10 \cdot \log(1/\text{Duty Cycle})$

Extreme Conditions (Temperature 70°C / AC 207V)

Mode	Ch. No.	Freq. (MHz)	RF Output Power (dBm)		Total EIRP Power (dBm)	Limit (dBm)	Result
			Ant 0	Ant 1			
11n-HT20	64	5320	3.91	3.58	14.01	17	Pass
11n-HT20	100	5500	11.48	12.51	22.28	24	Pass
11n-HT20	140	5700	10.91	11.24	21.34	24	Pass
11ac-VHT20	64	5320	3.55	3.61	14.25	17	Pass
11ac-VHT20	100	5500	11.24	11.52	22.06	24	Pass
11ac-VHT20	140	5700	11.06	11.26	21.83	24	Pass
11n-HT40	62	5310	3.61	3.29	13.68	17	Pass
11n-HT40	102	5510	11.82	11.52	21.90	24	Pass
11n-HT40	134	5670	11.68	11.62	21.88	24	Pass
11ac-VHT40	62	5310	3.42	3.52	13.77	17	Pass
11ac-VHT40	102	5510	11.69	11.36	21.83	24	Pass
11ac-VHT40	134	5670	10.42	10.55	20.79	24	Pass
11ac-VHT80	58	5290	3.26	2.75	13.99	17	Pass
11ac-VHT80	106	5530	10.39	10.45	21.40	24	Pass
11ac-VHT80	122	5610	10.24	10.14	21.17	24	Pass

Note: Total EIRP Power(dBm) = $10 \cdot \log\{10^{(\text{Ant 0 RF Output Power} / 10)} + 10^{(\text{Ant 1 RF Output Power} / 10)} + 10^{(\text{Ant 2 RF Output Power} / 10)}\} + \text{Antenna Gain(dBi)} + 10 \cdot \log(1/\text{Duty Cycle})$

Extreme Conditions (Temperature 70°C / AC 253V)

Mode	Ch. No.	Freq. (MHz)	RF Output Power (dBm)		Total EIRP Power (dBm)	Limit (dBm)	Result
			Ant 0	Ant 1			
11n-HT20	64	5320	3.86	3.66	14.02	17	Pass
11n-HT20	100	5500	11.59	12.48	22.32	24	Pass
11n-HT20	140	5700	10.86	11.43	21.41	24	Pass
11ac-VHT20	64	5320	3.64	3.85	14.42	17	Pass
11ac-VHT20	100	5500	11.39	11.81	22.28	24	Pass
11ac-VHT20	140	5700	11.36	11.42	22.06	24	Pass
11n-HT40	62	5310	3.82	3.46	13.87	17	Pass
11n-HT40	102	5510	11.64	11.35	21.73	24	Pass
11n-HT40	134	5670	11.58	11.42	21.73	24	Pass
11ac-VHT40	62	5310	3.29	3.42	13.66	17	Pass
11ac-VHT40	102	5510	11.46	11.24	21.65	24	Pass
11ac-VHT40	134	5670	10.36	10.35	20.66	24	Pass
11ac-VHT80	58	5290	3.03	2.84	13.91	17	Pass
11ac-VHT80	106	5530	10.16	10.24	21.18	24	Pass
11ac-VHT80	122	5610	10.16	10.35	21.23	24	Pass

Note: Total EIRP Power(dBm) = $10 \cdot \log\{10^{(\text{Ant 0 RF Output Power} / 10)} + 10^{(\text{Ant 1 RF Output Power} / 10)} + 10^{(\text{Ant 2 RF Output Power} / 10)}\} + \text{Antenna Gain(dBi)} + 10 \cdot \log(1/\text{Duty Cycle})$

Product	802.11ac Dual Band Module	Temperature	24°C
Test Engineer	Amy Zhang	Relative Humidity	54%
Test Site	TR3	Test Date	2017/01/05
Test Item	Power Density		

1Tx

Mode	Ch. No.	Freq. (MHz)	Power Density (dBm/MHz)		Max Power Density (dBm/MHz)	Limit (dBm/MHz)	Result
			Ant 0	Ant 1			
11a	36	5180	2.78	2.68	9.91	10	Pass
11a	64	5320	2.29	2.49	9.62	10	Pass
11a	100	5500	7.26	8.16	15.29	17	Pass
11a	140	5700	7.59	7.55	14.72	17	Pass
11n-HT20	36	5180	2.43	2.49	9.74	10	Pass
11n-HT20	64	5320	2.69	2.55	9.94	10	Pass
11n-HT20	100	5500	6.82	7.81	15.06	17	Pass
11n-HT20	140	5700	8.11	7.35	15.36	17	Pass
11ac-VHT20	36	5180	2.29	2.24	9.95	10	Pass
11ac-VHT20	64	5320	2.15	2.18	9.84	10	Pass
11ac-VHT20	100	5500	6.83	8.19	15.85	17	Pass
11ac-VHT20	140	5700	7.69	7.24	15.35	17	Pass
11n-HT40	38	5190	-1.35	-1.62	5.87	10	Pass
11n-HT40	62	5310	-1.41	-1.34	5.88	10	Pass
11n-HT40	102	5510	3.25	3.42	10.64	17	Pass
11n-HT40	134	5670	3.29	3.19	10.51	17	Pass
11ac-VHT40	38	5190	0.62	-0.38	7.91	10	Pass
11ac-VHT40	62	5310	-0.25	0.41	7.70	10	Pass
11ac-VHT40	102	5510	4.26	4.75	12.04	17	Pass
11ac-VHT40	134	5670	3.64	3.76	11.05	17	Pass
11ac-VHT80	42	5210	-3.25	-3.29	4.71	10	Pass
11ac-VHT80	58	5290	-3.19	-3.31	4.77	10	Pass
11ac-VHT80	106	5530	0.55	0.47	8.51	17	Pass
11ac-VHT80	122	5610	0.29	0.66	8.62	17	Pass

Note: Max Power Density (dBm/MHz) = Power Density + Antenna Gain + 10*Log(1/Duty Cycle).

2Tx

Mode	Ch. No.	Freq. (MHz)	Power Density (dBm/MHz)		Total Power Density (dBm/MHz)	Limit (dBm/MHz)	Result
			Ant 0	Ant 1			
11n-HT20	36	5180	-0.24	-0.91	9.70	10	Pass
11n-HT20	64	5320	-0.68	-0.84	9.50	10	Pass
11n-HT20	100	5500	5.75	6.85	16.59	17	Pass
11n-HT20	140	5700	6.48	6.03	16.52	17	Pass
11ac-VHT20	36	5180	-0.88	-1.25	9.61	10	Pass
11ac-VHT20	64	5320	-1.03	-1.54	9.40	10	Pass
11ac-VHT20	100	5500	5.44	6.57	16.71	17	Pass
11ac-VHT20	140	5700	6.26	5.88	16.75	17	Pass
11n-HT40	38	5190	-2.85	-2.94	7.34	10	Pass
11n-HT40	62	5310	-2.74	-2.88	7.42	10	Pass
11n-HT40	102	5510	4.24	3.84	14.27	17	Pass
11n-HT40	134	5670	5.14	4.58	15.10	17	Pass
11ac-VHT40	38	5190	-2.33	-2.47	7.90	10	Pass
11ac-VHT40	62	5310	-2.47	-2.58	7.78	10	Pass
11ac-VHT40	102	5510	3.36	4.03	14.01	17	Pass
11ac-VHT40	134	5670	4.91	4.58	15.05	17	Pass
11ac-VHT80	42	5210	-5.46	-5.14	5.68	10	Pass
11ac-VHT80	58	5290	-5.36	-5.03	5.78	10	Pass
11ac-VHT80	106	5530	-2.03	-1.77	9.08	17	Pass
11ac-VHT80	122	5610	-1.94	-1.85	9.08	17	Pass

Note: Total Power Density(dBm/MHz) = $10 \cdot \log\{10^{(\text{Ant 0 Power Density} / 10)} + 10^{(\text{Ant 1 Power Density} / 10)}\} + \text{Antenna Gain(dBi)} + 10 \cdot \log(1/\text{Duty Cycle})$.

7. Transmitter Unwanted Emissions Outside the 5GHz RLAN Bands

7.1. Limit

Frequency Range	Maximum Power	Bandwidth
30 MHz to 47 MHz	-36dBm	100 kHz
47 MHz to 74 MHz	-54dBm	100 kHz
74 MHz to 87.5 MHz	-36dBm	100 kHz
87.5 MHz to 118 MHz	-54dBm	100 kHz
118 MHz to 174 MHz	-36dBm	100 kHz
174 MHz to 230 MHz	-54dBm	100 kHz
230 MHz to 470 MHz	-36dBm	100 kHz
470 MHz to 862 MHz	-54dBm	100 kHz
862 MHz to 1 GHz	-36dBm	100 kHz
1 GHz to 5.15 GHz	-30dBm	1 MHz
5.35 GHz to 5.47 GHz	-30dBm	1 MHz
5.725 GHz to 26.5 GHz	-30dBm	1 MHz

7.2. Test Setup

Below 1GHz Test Setup:

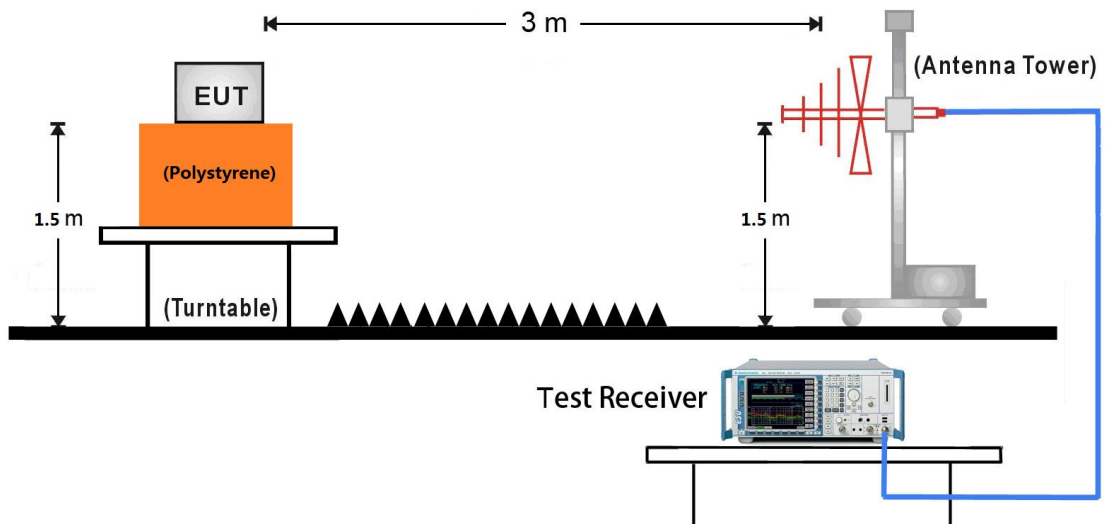

Above 1GHz Test Setup:

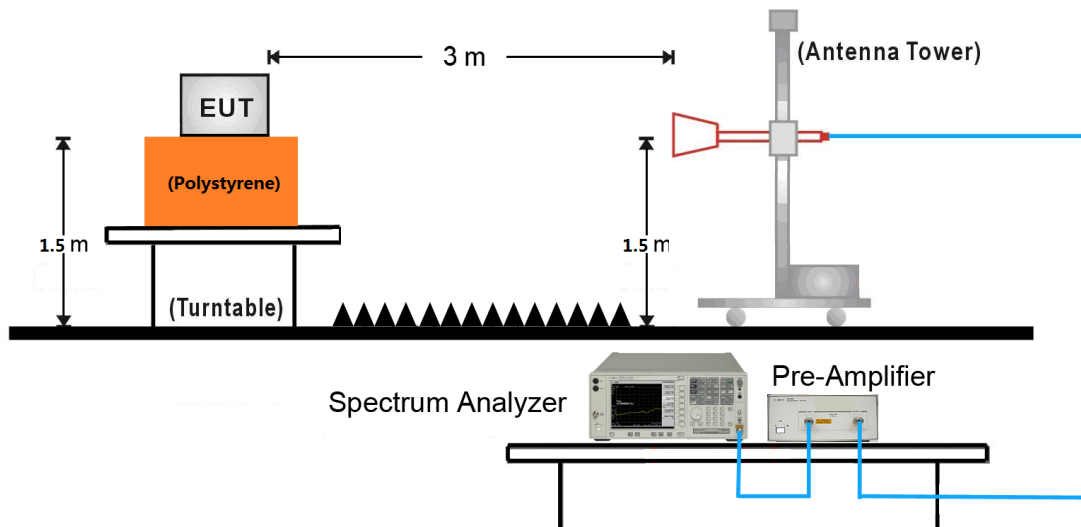

7.3. Test Procedure

Refer to ETSI EN 301 893 V1.8.1 (2015-03) Clause 5.3.5.2.2.

7.4. Test Result

Test with ANT 2#

Test Engineer	Lewis Huang	Temperature	24°C
Test Time	2016/12/24	Relative Humidity	52%
Test Mode	802.11a - Ant 1	Test Site	AC1

Channel	Frequency (MHz)	Reading Level (dBm)	Substitution Factor (dB)	Measure Level (dBm)	Limit (dBm)	Margin (dB)	Detector	Polarization
64	62.0	-84.6	22.9	-61.7	-54.0	-7.7	PK	Horizontal
	97.4	-77.6	14.7	-62.9	-54.0	-8.9	PK	Horizontal
	72.7	-89.4	25.9	-63.5	-54.0	-9.5	PK	Vertical
	750.2	-98.6	35.3	-63.3	-54.0	-9.3	PK	Vertical
	7596.0	-64.6	21.5	-43.1	-30.0	-13.1	PK	Horizontal
	14744.5	-74.9	29.8	-45.1	-30.0	-15.1	PK	Horizontal
	7596.0	-69.4	21.9	-47.5	-30.0	-17.5	PK	Vertical
	14702.0	-75.4	31.2	-44.2	-30.0	-14.2	PK	Vertical
100	62.5	-87.6	22.9	-64.7	-54.0	-10.7	PK	Horizontal
	190.1	-85.4	23.8	-61.6	-54.0	-7.6	PK	Horizontal
	57.2	-85.4	22.0	-63.4	-54.0	-9.4	PK	Vertical
	200.2	-86.9	22.5	-64.4	-54.0	-10.4	PK	Vertical
	7596.0	-67.9	21.5	-46.4	-30.0	-16.4	PK	Horizontal
	10826.0	-76.4	29.6	-46.8	-30.0	-16.8	PK	Horizontal
	7596.0	-71.2	21.9	-49.3	-30.0	-19.3	PK	Vertical
	14583.0	-72.9	30.8	-42.1	-30.0	-12.1	PK	Vertical

Note 1: Measure Level (dBm) = Reading Level (dBm) + Substitution Factor (dB)

Note 2: Substitution Factor (dB) = Cable Loss (dB) + Space Attenuation (dB) + Antenna Factor (dB/m) - Pre_Amplifier Gain (dB)

Note 3: Other frequency was base noise within 18-26.5GHz, there is not show in the report.

Test Engineer	Lewis Huang	Temperature	24°C
Test Time	2016/12/24	Relative Humidity	52%
Test Mode	802.11n-HT20 - Ant 0 + 1	Test Site	AC1

Channel	Frequency (MHz)	Reading Level (dBm)	Substitution Factor (dB)	Measure Level (dBm)	Limit (dBm)	Margin (dB)	Detector	Polarization
64	63.0	-86.0	22.8	-63.2	-54.0	-9.2	PK	Horizontal
	190.1	-86.8	23.8	-63.0	-54.0	-9.0	PK	Horizontal
	55.2	-84.2	21.8	-62.4	-54.0	-8.4	PK	Vertical
	197.8	-87.0	22.4	-64.6	-54.0	-10.6	PK	Vertical
	7094.5	-57.6	21.6	-36.0	-30.0	-6.0	PK	Horizontal
	11506.0	-73.0	28.8	-44.2	-30.0	-14.2	PK	Horizontal
	7093.3	-54.4	21.9	-32.5	-30.0	-2.5	RMS	Vertical
	14353.5	-74.0	31.0	-43.0	-30.0	-13.0	PK	Vertical
100	62.5	-85.1	22.9	-62.2	-54.0	-8.2	PK	Horizontal
	675.1	-97.3	32.7	-64.6	-54.0	-10.6	PK	Horizontal
	66.9	-85.7	24.7	-61.0	-54.0	-7.0	PK	Vertical
	750.2	-96.3	35.3	-61.0	-54.0	-7.0	PK	Vertical
	7332.5	-64.1	22.1	-42.0	-30.0	-12.0	PK	Horizontal
	10919.5	-73.9	29.8	-44.1	-30.0	-14.1	PK	Horizontal
	7332.5	-65.5	22.1	-43.4	-30.0	-13.4	PK	Vertical
	10979.0	-73.9	29.4	-44.5	-30.0	-14.5	PK	Vertical

Note 1: Measure Level (dBm) = Reading Level (dBm) + Substitution Factor (dB)

Note 2: Substitution Factor (dB) = Cable Loss (dB) + Space Attenuation (dB) + Antenna Factor (dB/m) - Pre_Amplifier Gain (dB)

Note 3: Other frequency was base noise within 18-26.5GHz, there is not show in the report.

Test Engineer	Lewis Huang	Temperature	24°C
Test Time	2016/12/24	Relative Humidity	52%
Test Mode	802.11n-HT40 - Ant 0 + 1	Test Site	AC1

Channel	Frequency (MHz)	Reading Level (dBm)	Substitution Factor (dB)	Measure Level (dBm)	Limit (dBm)	Margin (dB)	Detector	Polarization
62	62.5	-84.5	22.9	-61.6	-54.0	-7.6	PK	Horizontal
	750.2	-95.5	35.6	-59.9	-54.0	-5.9	RMS	Horizontal
	66.9	-85.5	24.7	-60.8	-54.0	-6.8	PK	Vertical
	750.2	-96.2	35.3	-60.9	-54.0	-6.9	PK	Vertical
	7094.5	-57.0	21.6	-35.4	-30.0	-5.4	RMS	Horizontal
	10919.5	-74.2	29.8	-44.4	-30.0	-14.4	PK	Horizontal
	7093.3	-54.2	21.9	-32.3	-30.0	-2.3	RMS	Vertical
	13724.5	-72.3	30.1	-42.2	-30.0	-12.2	PK	Vertical
102	61.5	-85.1	22.7	-62.4	-54.0	-8.4	PK	Horizontal
	749.7	-95.2	35.6	-59.6	-54.0	-5.6	RMS	Horizontal
	66.9	-85.7	24.7	-61.0	-54.0	-7.0	PK	Vertical
	750.2	-98.4	35.3	-63.1	-54.0	-9.1	PK	Vertical
	7358.0	-63.3	22.1	-41.2	-30.0	-11.2	PK	Horizontal
	10877.0	-74.0	29.7	-44.3	-30.0	-14.3	PK	Horizontal
	7358.0	-63.8	22.3	-41.5	-30.0	-11.5	PK	Vertical
	11038.5	-72.6	29.2	-43.4	-30.0	-13.4	PK	Vertical

Note 1: Measure Level (dBm) = Reading Level (dBm) + Substitution Factor (dB)

Note 2: Substitution Factor (dB) = Cable Loss (dB) + Space Attenuation (dB) + Antenna Factor (dB/m) - Pre_Amplifier Gain (dB)

Note 3: Other frequency was base noise within 18-26.5GHz, there is not show in the report.

Test Engineer	Lewis Huang	Temperature	24°C
Test Time	2016/12/24	Relative Humidity	52%
Test Mode	802.11ac-VHT20 - Ant 0 + 1	Test Site	AC1

Channel	Frequency (MHz)	Reading Level (dBm)	Substitution Factor (dB)	Measure Level (dBm)	Limit (dBm)	Margin (dB)	Detector	Polarization
64	62.0	-85.0	22.9	-62.1	-54.0	-8.1	PK	Horizontal
	190.1	-84.7	23.8	-60.9	-54.0	-6.9	PK	Horizontal
	66.4	-86.1	24.7	-61.4	-54.0	-7.4	PK	Vertical
	750.2	-96.4	35.3	-61.1	-54.0	-7.1	PK	Vertical
	7094.5	-58.6	21.6	-37.0	-30.0	-7.0	PK	Horizontal
	10868.5	-73.8	29.5	-44.3	-30.0	-14.3	PK	Horizontal
	7093.2	-54.6	21.9	-32.7	-30.0	-2.7	RMS	Vertical
	14158.0	-73.6	31.0	-42.6	-30.0	-12.6	PK	Vertical
100	90.6	-78.4	15.7	-62.7	-54.0	-8.7	PK	Horizontal
	750.2	-95.4	35.6	-59.8	-54.0	-5.8	RMS	Horizontal
	66.9	-85.1	24.7	-60.4	-54.0	-6.4	PK	Vertical
	500.0	-90.9	29.8	-61.1	-54.0	-7.1	PK	Vertical
	7332.5	-66.7	22.1	-44.6	-30.0	-14.6	PK	Horizontal
	10911.0	-74.9	30.1	-44.8	-30.0	-14.8	PK	Horizontal
	7332.5	-66.0	22.1	-43.9	-30.0	-13.9	PK	Vertical
	10894.0	-73.8	29.8	-44.0	-30.0	-14.0	PK	Vertical

Note 1: Measure Level (dBm) = Reading Level (dBm) + Substitution Factor (dB)

Note 2: Substitution Factor (dB) = Cable Loss (dB) + Space Attenuation (dB) + Antenna Factor (dB/m) - Pre_Amplifier Gain (dB)

Note 3: Other frequency was base noise within 18-26.5GHz, there is not show in the report.

Test Engineer	Lewis Huang	Temperature	24°C
Test Time	2016/12/24	Relative Humidity	52%
Test Mode	802.11ac-VHT40 - Ant 0 + 1 + 2	Test Site	AC1

Channel	Frequency (MHz)	Reading Level (dBm)	Substitution Factor (dB)	Measure Level (dBm)	Limit (dBm)	Margin (dB)	Detector	Polarization
62	62.5	-85.4	22.9	-62.5	-54.0	-8.5	PK	Horizontal
	190.1	-85.1	23.8	-61.3	-54.0	-7.3	PK	Horizontal
	66.9	-85.9	24.7	-61.2	-54.0	-7.2	PK	Vertical
	500.0	-91.2	29.8	-61.4	-54.0	-7.4	PK	Vertical
	7077.5	-64.6	21.5	-43.1	-30.0	-13.1	PK	Horizontal
	11030.0	-74.2	29.3	-44.9	-30.0	-14.9	PK	Horizontal
	7077.5	-58.6	21.6	-37.0	-30.0	-7.0	PK	Vertical
	11064.0	-74.8	29.2	-45.6	-30.0	-15.6	PK	Vertical
102	62.0	-85.2	22.9	-62.3	-54.0	-8.3	PK	Horizontal
	625.1	-92.7	32.6	-60.1	-54.0	-6.1	PK	Horizontal
	66.9	-85.8	24.7	-61.1	-54.0	-7.1	PK	Vertical
	201.2	-84.9	22.4	-62.5	-54.0	-8.5	PK	Vertical
	7349.5	-66.7	22.0	-44.7	-30.0	-14.7	PK	Horizontal
	10902.5	-74.3	29.8	-44.5	-30.0	-14.5	PK	Horizontal
	7349.5	-67.4	22.4	-45.0	-30.0	-15.0	PK	Vertical
	10885.5	-75.2	29.7	-45.5	-30.0	-15.5	PK	Vertical

Note 1: Measure Level (dBm) = Reading Level (dBm) + Substitution Factor (dB)

Note 2: Substitution Factor (dB) = Cable Loss (dB) + Space Attenuation (dB) + Antenna Factor (dB/m) - Pre_Amplifier Gain (dB)

Note 3: Other frequency was base noise within 18-26.5GHz, there is not show in the report.

Test Engineer	Lewis Huang	Temperature	24°C
Test Time	2016/12/24	Relative Humidity	52%
Test Mode	802.11ac-VHT80 - Ant 0 + 1	Test Site	AC1

Channel	Frequency (MHz)	Reading Level (dBm)	Substitution Factor (dB)	Measure Level (dBm)	Limit (dBm)	Margin (dB)	Detector	Polarization
62	61.5	-85.3	22.7	-62.6	-54.0	-8.6	PK	Horizontal
	750.2	-96.0	35.6	-60.4	-54.0	-6.4	PK	Horizontal
	66.9	-86.2	24.7	-61.5	-54.0	-7.5	PK	Vertical
	201.7	-85.5	22.3	-63.2	-54.0	-9.2	PK	Vertical
	7043.5	-62.0	21.1	-40.9	-30.0	-10.9	PK	Horizontal
	10902.5	-74.3	29.8	-44.5	-30.0	-14.5	PK	Horizontal
	7040.0	-54.9	21.5	-33.4	-30.0	-3.4	RMS	Vertical
	10919.5	-75.6	29.7	-45.9	-30.0	-15.9	PK	Vertical
102	61.5	-84.9	22.7	-62.2	-54.0	-8.2	PK	Horizontal
	749.7	-97.2	35.6	-61.6	-54.0	-7.6	PK	Horizontal
	66.4	-85.8	24.7	-61.1	-54.0	-7.1	PK	Vertical
	750.2	-96.7	35.3	-61.4	-54.0	-7.4	PK	Vertical
	7358.0	-67.2	22.1	-45.1	-30.0	-15.1	PK	Horizontal
	13877.5	-73.9	29.8	-44.1	-30.0	-14.1	PK	Horizontal
	7358.0	-68.4	22.3	-46.1	-30.0	-16.1	PK	Vertical
	14676.5	-74.8	31.4	-43.4	-30.0	-13.4	PK	Vertical

Note 1: Measure Level (dBm) = Reading Level (dBm) + Substitution Factor (dB)

Note 2: Substitution Factor (dB) = Cable Loss (dB) + Space Attenuation (dB) + Antenna Factor (dB/m) - Pre_Amplifier Gain (dB)

Note 3: Other frequency was base noise within 18-26.5GHz, there is not show in the report.

Test with ANT 3#

Test Engineer	Lewis Huang	Temperature	24°C
Test Time	2016/12/24	Relative Humidity	52%
Test Mode	802.11a - Ant 1	Test Site	AC2

Channel	Frequency (MHz)	Reading Level (dBm)	Substitution Factor (dB)	Measure Level (dBm)	Limit (dBm)	Margin (dB)	Detector	Polarization
64	559.4	-91.6	31.5	-60.1	-54	-6.1	PK	Horizontal
	579.3	-95.7	31.2	-64.5	-54	-10.5	PK	Horizontal
	559.4	-91.8	30.2	-61.6	-54	-7.6	PK	Vertical
	850.9	-95.1	35.9	-59.2	-54	-5.2	PK	Vertical
	9346.3	-73.7	27.1	-46.6	-30	-16.6	PK	Horizontal
	12992.8	-74.6	31.5	-43.1	-30	-13.1	PK	Horizontal
	9312.3	-72.6	28.6	-44.0	-30	-14.0	PK	Vertical
	12992.8	-74.9	32.2	-42.7	-30	-12.7	PK	Vertical
100	66.6	-88.2	20.2	-68.0	-54	-14.0	PK	Horizontal
	559.4	-92.0	31.5	-60.5	-54	-6.5	PK	Horizontal
	64.2	-89.4	22.3	-67.1	-54	-13.1	PK	Vertical
	559.4	-92.0	30.2	-61.8	-54	-7.8	PK	Vertical
	9023.3	-72.7	26.1	-46.6	-30	-16.6	PK	Horizontal
	14803.3	-74.6	34.1	-40.5	-30	-10.5	PK	Horizontal
	9669.3	-72.9	28.7	-44.2	-30	-14.2	PK	Vertical
	13672.8	-73.5	31.8	-41.7	-30	-11.7	PK	Vertical

Note 1: Measure Level (dBm) = Reading Level (dBm) + Substitution Factor (dB)

Note 2: Substitution Factor (dB) = Cable Loss (dB) + Space Attenuation (dB) + Antenna Factor (dB/m) - Pre_Amplifier Gain (dB)

Note 3: Other frequency was base noise within 18-26.5GHz, there is not show in the report.

Test Engineer	Lewis Huang	Temperature	24°C
Test Time	2016/12/24	Relative Humidity	52%
Test Mode	802.11n-HT20 - Ant 0 + 1	Test Site	AC2

Channel	Frequency (MHz)	Reading Level (dBm)	Substitution Factor (dB)	Measure Level (dBm)	Limit (dBm)	Margin (dB)	Detector	Polarization
64	64.7	-89.7	20.5	-69.2	-54	-15.2	PK	Horizontal
	559.4	-92.1	31.5	-60.6	-54	-6.6	PK	Horizontal
	64.7	-89.1	22.1	-67.0	-54	-13.0	PK	Vertical
	559.4	-92.1	30.2	-61.9	-54	-7.9	PK	Vertical
	11624.3	-74.5	31.1	-43.4	-30	-13.4	PK	Horizontal
	14820.3	-74.3	34.1	-40.2	-30	-10.2	PK	Horizontal
	8691.8	-72.6	27.0	-45.6	-30	-15.6	PK	Vertical
	13791.8	-74.7	32.4	-42.3	-30	-12.3	PK	Vertical
100	559.4	-93.6	31.5	-62.1	-54	-8.1	PK	Horizontal
	839.3	-96.1	35.0	-61.1	-54	-7.1	PK	Horizontal
	65.2	-87.1	21.9	-65.2	-54	-11.2	PK	Vertical
	559.4	-91.7	30.2	-61.5	-54	-7.5	PK	Vertical
	9720.3	-72.2	27.3	-44.9	-30	-14.9	PK	Horizontal
	14794.8	-74.3	34.2	-40.1	-30	-10.1	PK	Horizontal
	7450.8	-72.2	25.4	-46.8	-30	-16.8	PK	Vertical
	10944.3	-74.1	30.5	-43.6	-30	-13.6	PK	Vertical

Note 1: Measure Level (dBm) = Reading Level (dBm) + Substitution Factor (dB)

Note 2: Substitution Factor (dB) = Cable Loss (dB) + Space Attenuation (dB) + Antenna Factor (dB/m) - Pre_Amplifier Gain (dB)

Note 3: Other frequency was base noise within 18-26.5GHz, there is not show in the report.

Test Engineer	Lewis Huang	Temperature	24°C
Test Time	2016/12/24	Relative Humidity	52%
Test Mode	802.11n-HT40 - Ant 0 + 1	Test Site	AC2

Channel	Frequency (MHz)	Reading Level (dBm)	Substitution Factor (dB)	Measure Level (dBm)	Limit (dBm)	Margin (dB)	Detector	Polarization
62	64.7	-90.5	20.5	-70.0	-54	-16.0	PK	Horizontal
	559.4	-93.3	31.5	-61.8	-54	-7.8	PK	Horizontal
	58.4	-89.7	21.8	-67.9	-54	-13.9	PK	Vertical
	559.4	-91.9	30.2	-61.7	-54	-7.7	PK	Vertical
	11624.3	-74.5	31.1	-43.4	-30	-13.4	PK	Horizontal
	14803.3	-74.6	34.1	-40.5	-30	-10.5	PK	Horizontal
	9414.3	-73.2	29.4	-43.8	-30	-13.8	PK	Vertical
	13366.8	-75.3	32.8	-42.5	-30	-12.5	PK	Vertical
102	64.2	-89.3	20.7	-68.6	-54	-14.6	PK	Horizontal
	559.4	-91.4	31.5	-59.9	-54	-5.9	PK	Horizontal
	68.6	-87.5	21.9	-65.6	-54	-11.6	PK	Vertical
	559.4	-91.7	30.2	-61.5	-54	-7.5	PK	Vertical
	11505.3	-74.6	30.4	-44.2	-30	-14.2	PK	Horizontal
	15270.8	-72.9	33.1	-39.8	-30	-9.8	PK	Horizontal
	10969.8	-74.1	30.5	-43.6	-30	-13.6	PK	Vertical
	12984.3	-74.0	32.2	-41.8	-30	-11.8	PK	Vertical

Note 1: Measure Level (dBm) = Reading Level (dBm) + Substitution Factor (dB)

Note 2: Substitution Factor (dB) = Cable Loss (dB) + Space Attenuation (dB) + Antenna Factor (dB/m) - Pre_Amplifier Gain (dB)

Note 3: Other frequency was base noise within 18-26.5GHz, there is not show in the report.

Test Engineer	Lewis Huang	Temperature	24°C
Test Time	2016/12/24	Relative Humidity	52%
Test Mode	802.11ac-VHT20 - Ant 0 + 1	Test Site	AC2

Channel	Frequency (MHz)	Reading Level (dBm)	Substitution Factor (dB)	Measure Level (dBm)	Limit (dBm)	Margin (dB)	Detector	Polarization
64	64.2	-90.0	20.7	-69.3	-54	-15.3	PK	Horizontal
	559.4	-91.9	31.5	-60.4	-54	-6.4	PK	Horizontal
	68.6	-88.5	21.9	-66.6	-54	-12.6	PK	Vertical
	559.4	-92.3	30.2	-62.1	-54	-8.1	PK	Vertical
	10935.8	-74.1	29.5	-44.6	-30	-14.6	PK	Horizontal
	15364.3	-73.1	32.8	-40.3	-30	-10.3	PK	Horizontal
	10570.3	-73.1	29.4	-43.7	-30	-13.7	PK	Vertical
	13630.3	-74.9	32.6	-42.3	-30	-12.3	PK	Vertical
100	64.2	-89.6	20.7	-68.9	-54	-14.9	PK	Horizontal
	559.4	-92.0	31.5	-60.5	-54	-6.5	PK	Horizontal
	65.2	-88.5	21.9	-66.6	-54	-12.6	PK	Vertical
	559.4	-92.1	30.2	-61.9	-54	-7.9	PK	Vertical
	11615.8	-74.8	30.8	-44.0	-30	-14.0	PK	Horizontal
	16494.8	-67.4	31.4	-36.0	-30	-6.0	PK	Horizontal
	7986.3	-72.1	25.2	-46.9	-30	-16.9	PK	Vertical
	16494.8	-68.8	33.3	-35.5	-30	-5.5	PK	Vertical

Note 1: Measure Level (dBm) = Reading Level (dBm) + Substitution Factor (dB)

Note 2: Substitution Factor (dB) = Cable Loss (dB) + Space Attenuation (dB) + Antenna Factor (dB/m) - Pre_Amplifier Gain (dB)

Note 3: Other frequency was base noise within 18-26.5GHz, there is not show in the report.

Test Engineer	Lewis Huang	Temperature	24°C
Test Time	2016/12/24	Relative Humidity	52%
Test Mode	802.11ac-VHT40 - Ant 0 + 1	Test Site	AC2

Channel	Frequency (MHz)	Reading Level (dBm)	Substitution Factor (dB)	Measure Level (dBm)	Limit (dBm)	Margin (dB)	Detector	Polarization
62	65.2	-88.7	20.4	-68.3	-54	-14.3	PK	Horizontal
	559.4	-91.7	31.5	-60.2	-54	-6.2	PK	Horizontal
	65.7	-88.7	21.8	-66.9	-54	-12.9	PK	Vertical
	559.4	-92.0	30.2	-61.8	-54	-7.8	PK	Vertical
	7476.3	-72.1	23.6	-48.5	-30	-18.5	PK	Horizontal
	15177.3	-73.1	33.3	-39.8	-30	-9.8	PK	Horizontal
	11590.3	-74.2	31.4	-42.8	-30	-12.8	PK	Vertical
	15185.8	-73.5	33.1	-40.4	-30	-10.4	PK	Vertical
102	559.4	-92.2	31.5	-60.7	-54	-6.7	PK	Horizontal
	579.3	-96.0	31.2	-64.8	-54	-10.8	PK	Horizontal
	64.2	-89.2	22.3	-66.9	-54	-12.9	PK	Vertical
	559.4	-91.7	30.2	-61.5	-54	-7.5	PK	Vertical
	11590.3	-74.8	31.1	-43.7	-30	-13.7	PK	Horizontal
	14361.3	-73.8	33.0	-40.8	-30	-10.8	PK	Horizontal
	11641.3	-74.5	31.5	-43.0	-30	-13.0	PK	Vertical
	15185.8	-73.3	33.1	-40.2	-30	-10.2	PK	Vertical

Note 1: Measure Level (dBm) = Reading Level (dBm) + Substitution Factor (dB)

Note 2: Substitution Factor (dB) = Cable Loss (dB) + Space Attenuation (dB) + Antenna Factor (dB/m) - Pre_Amplifier Gain (dB)

Note 3: Other frequency was base noise within 18-26.5GHz, there is not show in the report.

Test Engineer	Lewis Huang	Temperature	24°C
Test Time	2016/12/24	Relative Humidity	52%
Test Mode	802.11ac-VHT80 - Ant 0 + 1	Test Site	AC2

Channel	Frequency (MHz)	Reading Level (dBm)	Substitution Factor (dB)	Measure Level (dBm)	Limit (dBm)	Margin (dB)	Detector	Polarization
58	69.1	-88.8	19.7	-69.1	-54	-15.1	PK	Horizontal
	559.4	-91.9	31.5	-60.4	-54	-6.4	PK	Horizontal
	94.3	-100.7	33.6	-67.1	-54	-13.1	PK	Vertical
	559.4	-91.6	30.2	-61.4	-54	-7.4	PK	Vertical
	10383.3	-73.5	27.8	-45.7	-30	-15.7	PK	Horizontal
	14531.3	-73.7	32.7	-41.0	-30	-11.0	PK	Horizontal
	10935.8	-72.2	30.6	-41.6	-30	-11.6	PK	Vertical
	15542.8	-73.8	33.4	-40.4	-30	-10.4	PK	Vertical
106	64.2	-89.1	20.7	-68.4	-54	-14.4	PK	Horizontal
	559.4	-91.8	31.5	-60.3	-54	-6.3	PK	Horizontal
	64.7	-87.9	22.1	-65.8	-54	-11.8	PK	Vertical
	559.4	-92.2	30.2	-62.0	-54	-8.0	PK	Vertical
	11556.3	-74.4	30.5	-43.9	-30	-13.9	PK	Horizontal
	15151.8	-73.7	33.4	-40.3	-30	-10.3	PK	Horizontal
	9303.8	-73.9	28.8	-45.1	-30	-15.1	PK	Vertical
	13800.3	-74.6	32.7	-41.9	-30	-11.9	PK	Vertical

Note 1: Measure Level (dBm) = Reading Level (dBm) + Substitution Factor (dB)

Note 2: Substitution Factor (dB) = Cable Loss (dB) + Space Attenuation (dB) + Antenna Factor (dB/m) - Pre_Amplifier Gain (dB)

Note 3: Other frequency was base noise within 18-26.5GHz, there is not show in the report.

8. Transmitter Unwanted Emissions Within the 5GHz RLAN Bands

8.1. Limit

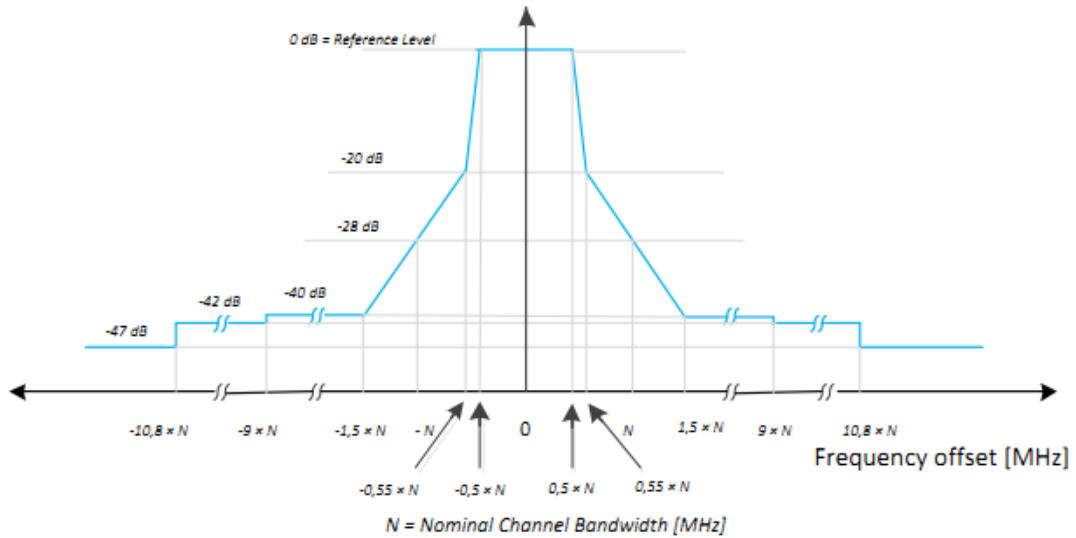
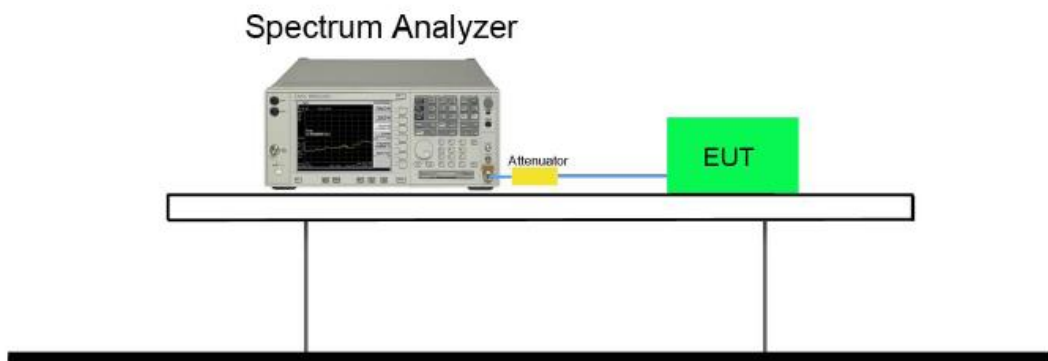

Figure : Transmit spectral power mask

8.2. Test Setup

Conducted measurements



8.3. Test Procedure

Refer to ETSI EN 301 893 V1.8.1 (2015-03) Clause 5.3.6.2.1.

8.4. Test Result

Product	802.11ac Dual Band Module	Temperature	20°C
Test Engineer	Amy Zhang	Relative Humidity	50%
Test Site	TR3	Test Date	2015/06/12

1Tx

Test Mode	Channel No.	Frequency (MHz)	Result
11a	36	5180	Pass
11a	64	5320	Pass
11a	100	5500	Pass
11a	140	5700	Pass
11n-HT20	36	5180	Pass
11n-HT20	64	5320	Pass
11n-HT20	100	5500	Pass
11n-HT20	140	5700	Pass
11n-HT40	38	5190	Pass
11n-HT40	62	5310	Pass
11n-HT40	102	5510	Pass
11n-HT40	134	5670	Pass
802.11ac-VHT20	36	5180	Pass
802.11ac-VHT20	64	5320	Pass
802.11ac-VHT20	100	5500	Pass
802.11ac-VHT20	140	5700	Pass
802.11ac-VHT40	38	5190	Pass
802.11ac-VHT40	62	5310	Pass
802.11ac-VHT40	102	5510	Pass
802.11ac-VHT40	134	5670	Pass
802.11ac-VHT80	42	5210	Pass
802.11ac-VHT80	58	5290	Pass
802.11ac-VHT80	106	5530	Pass
802.11ac-VHT80	122	5610	Pass

2Tx

Test Mode	Channel No.	Frequency (MHz)	Result
802.11n-HT20	36	5180	Pass
802.11n-HT20	64	5320	Pass
802.11n-HT20	100	5500	Pass
802.11n-HT20	140	5700	Pass
802.11n-HT40	38	5190	Pass
802.11n-HT40	62	5310	Pass
802.11n-HT40	102	5510	Pass
802.11n-HT40	134	5670	Pass
802.11ac-VHT20	36	5180	Pass
802.11ac-VHT20	64	5320	Pass
802.11ac-VHT20	100	5500	Pass
802.11ac-VHT20	140	5700	Pass
802.11ac-VHT40	38	5190	Pass
802.11ac-VHT40	62	5310	Pass
802.11ac-VHT40	102	5510	Pass
802.11ac-VHT40	134	5670	Pass
802.11ac-VHT80	42	5210	Pass
802.11ac-VHT80	58	5290	Pass
802.11ac-VHT80	106	5530	Pass
802.11ac-VHT80	122	5610	Pass

802.11a Transmitter Unwanted Emissions Within the 5GHz RLAN Bands – 1Tx

Channel 36 (5180MHz)

The Reference Level

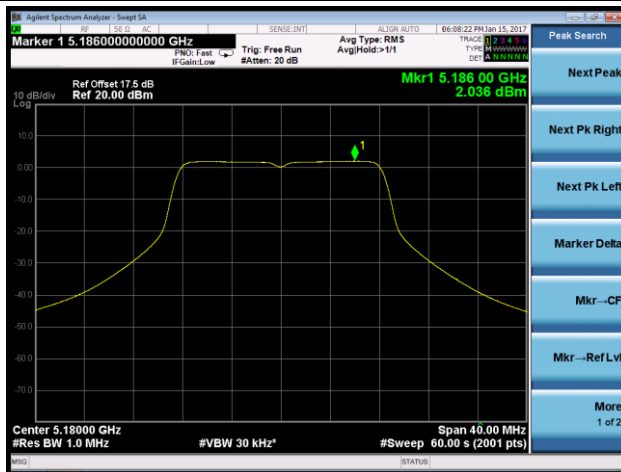

The Mask Data

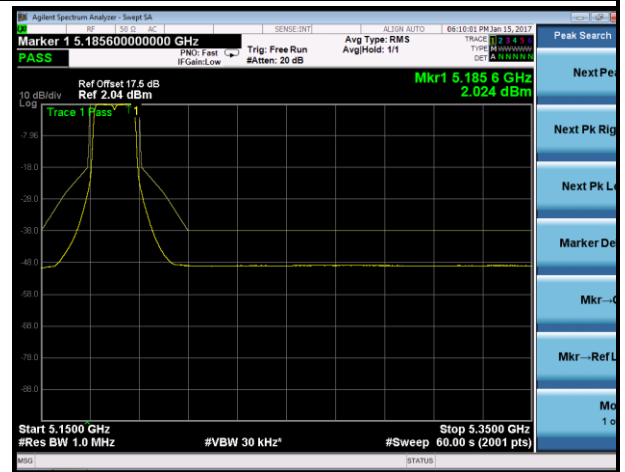

Channel 64 (5320MHz)

The Reference Level

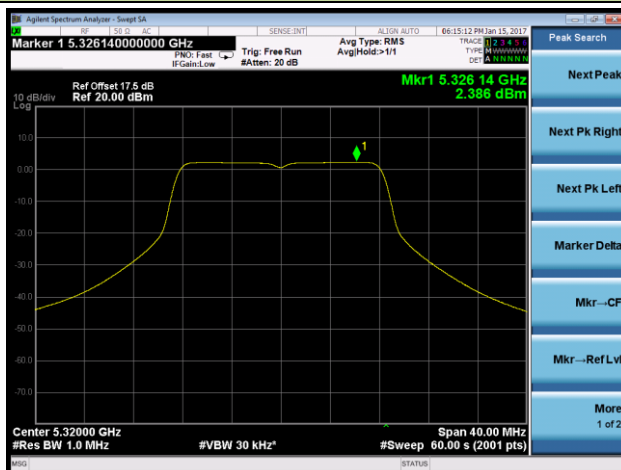

The Mask Data

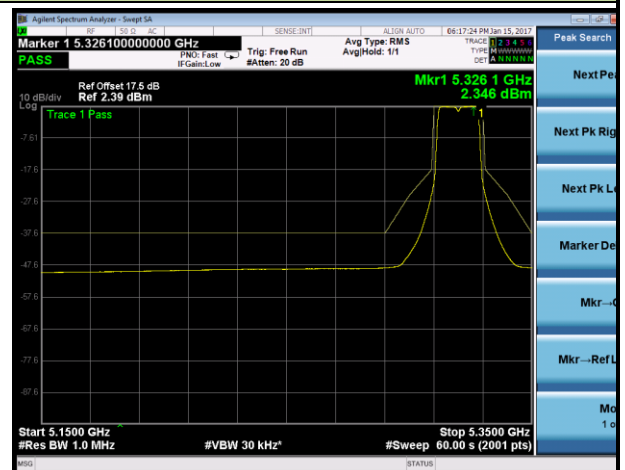

Channel 100 (5500MHz)

The Reference Level

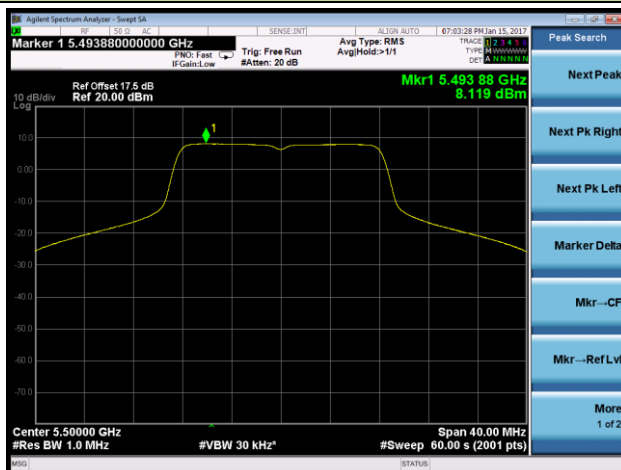

The Mask Data

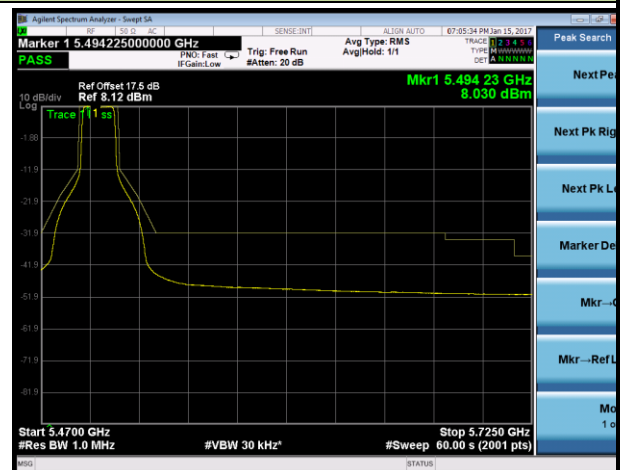

Channel 140 (5700MHz)

The Reference Level

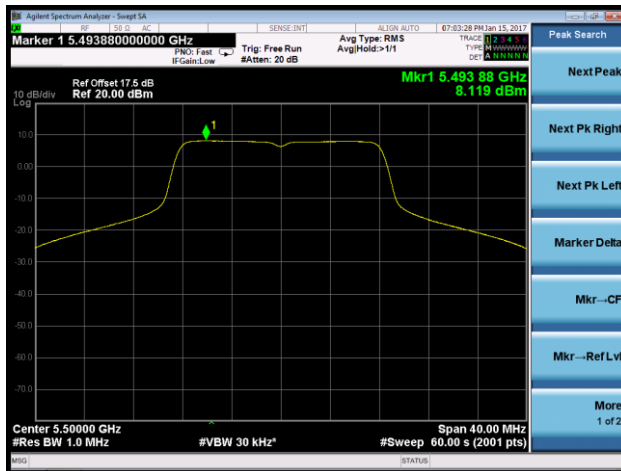

The Mask Data

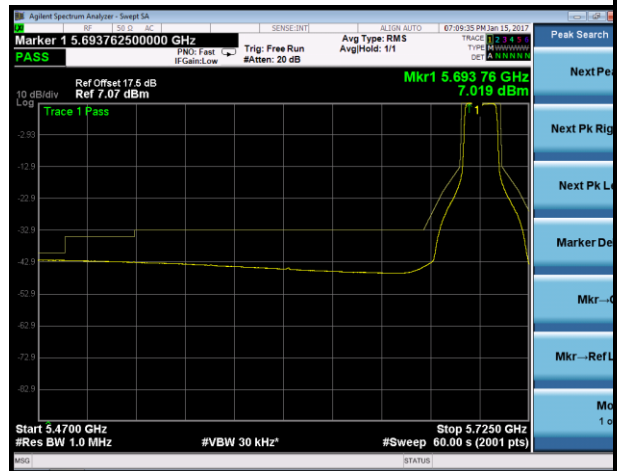

802.11n-HT20 Transmitter Unwanted Emissions Within the 5GHz RLAN Bands – 1Tx

Channel 36 (5180MHz)

The Reference Level

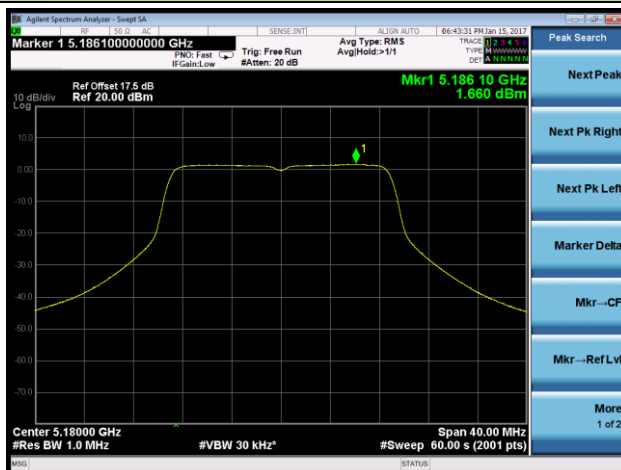

The Mask Data

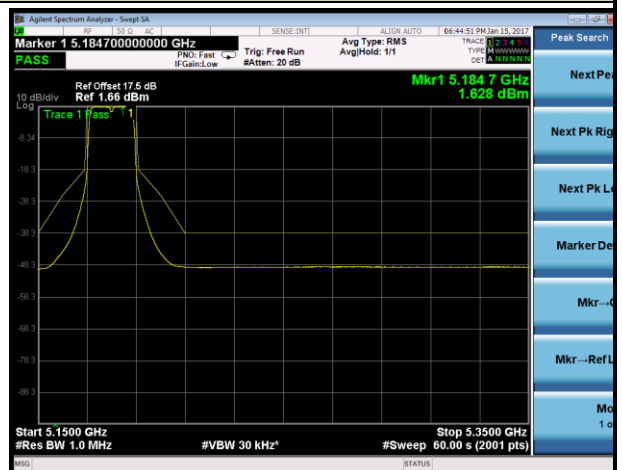

Channel 64 (5320MHz)

The Reference Level

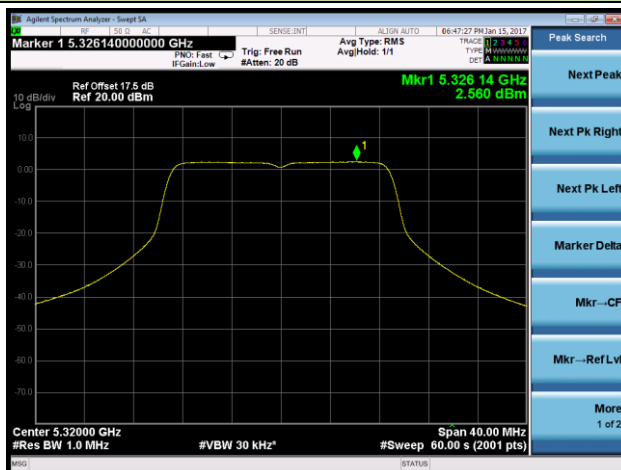

The Mask Data

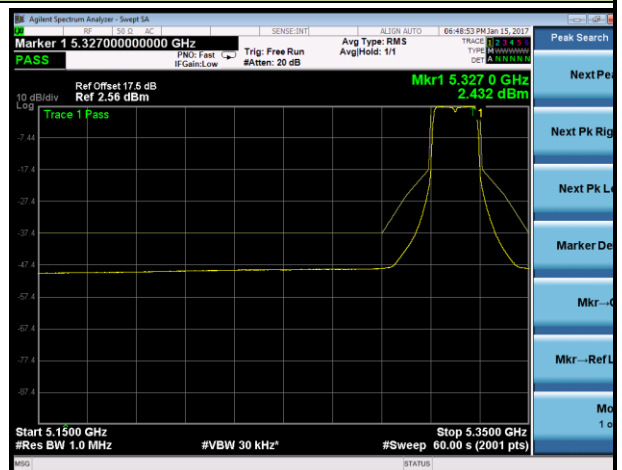

Channel 100 (5500MHz)

The Reference Level

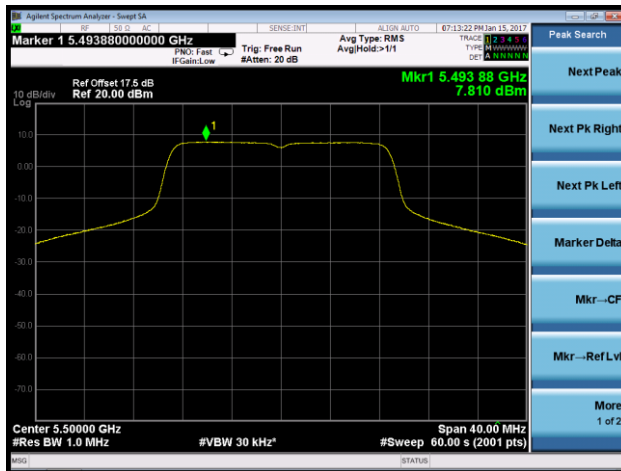

The Mask Data

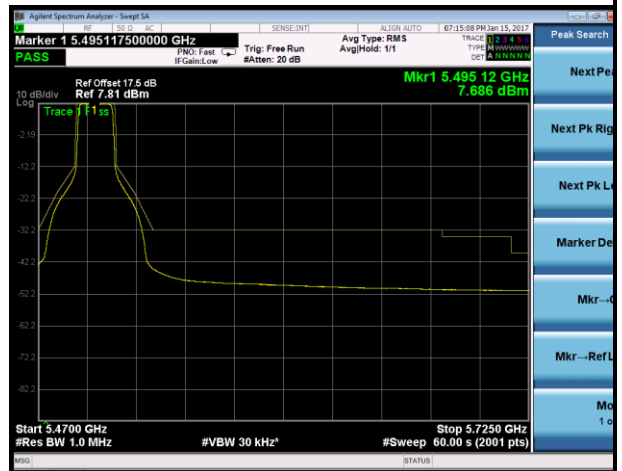

Channel 140 (5700MHz)

The Reference Level

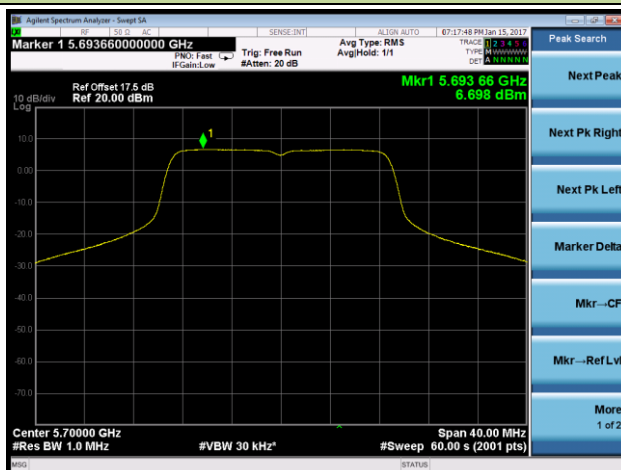

The Mask Data

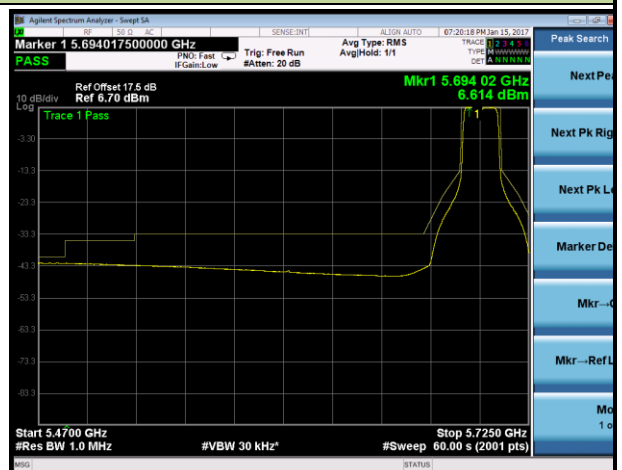

802.11n-HT40 Transmitter Unwanted Emissions Within the 5GHz RLAN Bands – 1Tx

Channel 38 (5190MHz)

The Reference Level

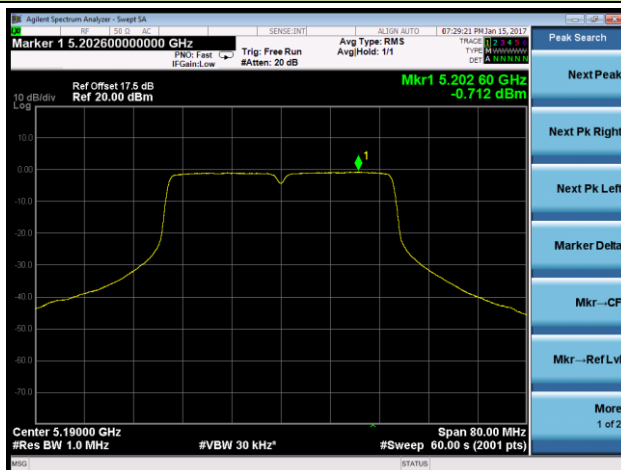

The Mask Data

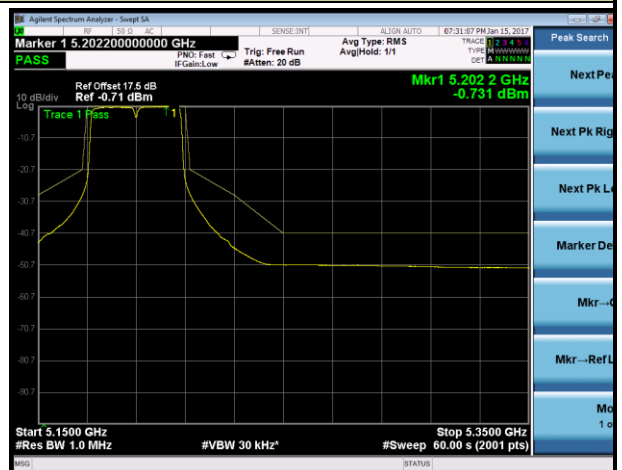

Channel 62 (5310MHz)

The Reference Level

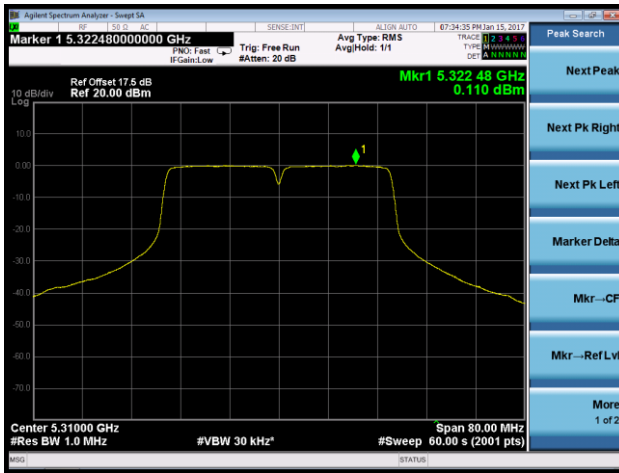

The Mask Data

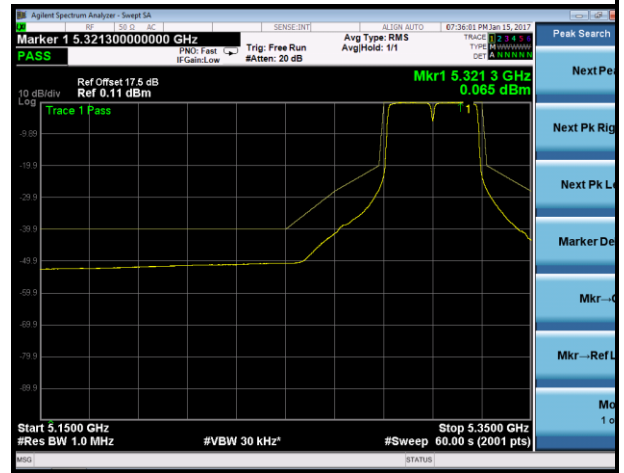

Channel 102 (5510MHz)

The Reference Level

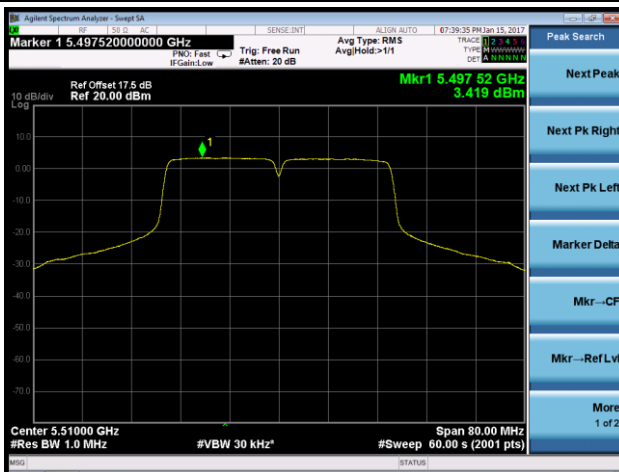

The Mask Data



Channel 134 (5670MHz)

The Reference Level

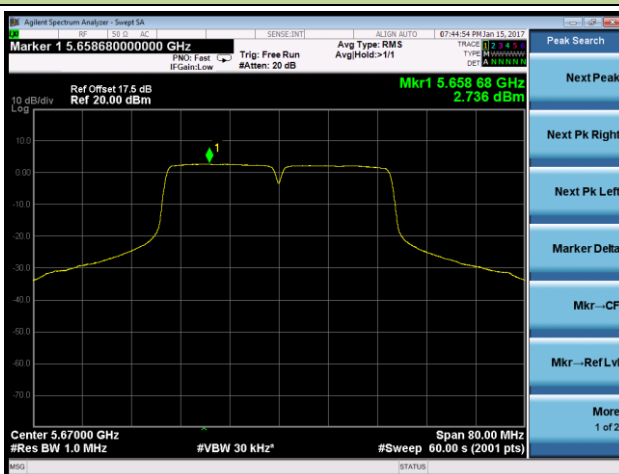

The Mask Data

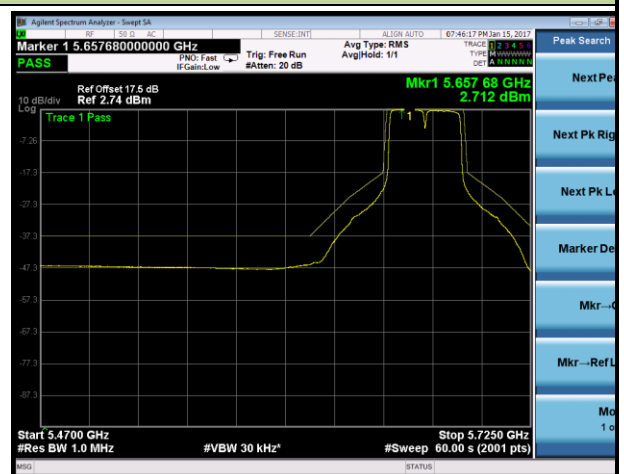

802.11ac-VHT20 Transmitter Unwanted Emissions Within the 5GHz RLAN Bands – 1Tx

Channel 36 (5180MHz)

The Reference Level

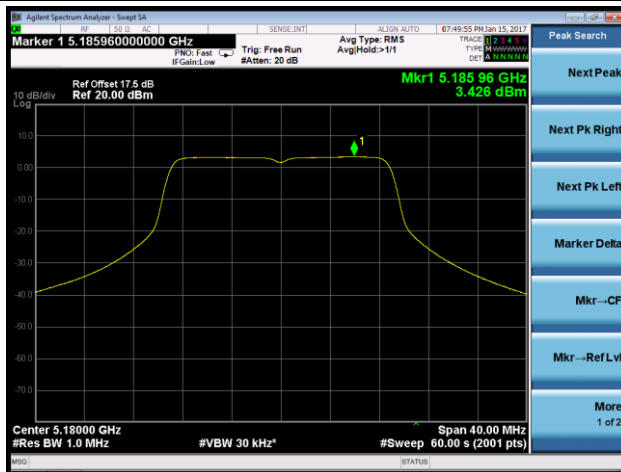

The Mask Data

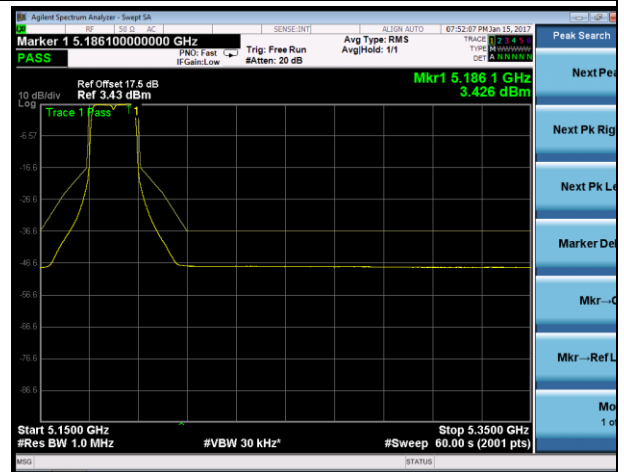

Channel 64 (5320MHz)

The Reference Level

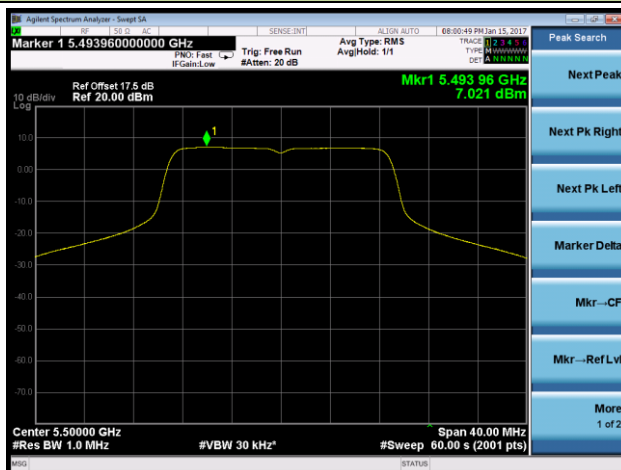

The Mask Data

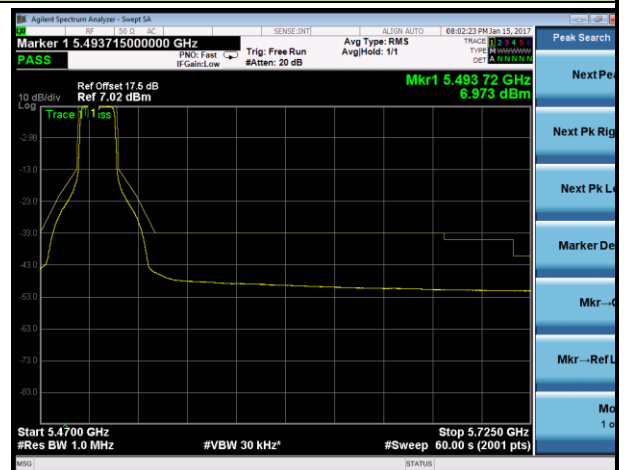

Channel 100 (5500MHz)

The Reference Level

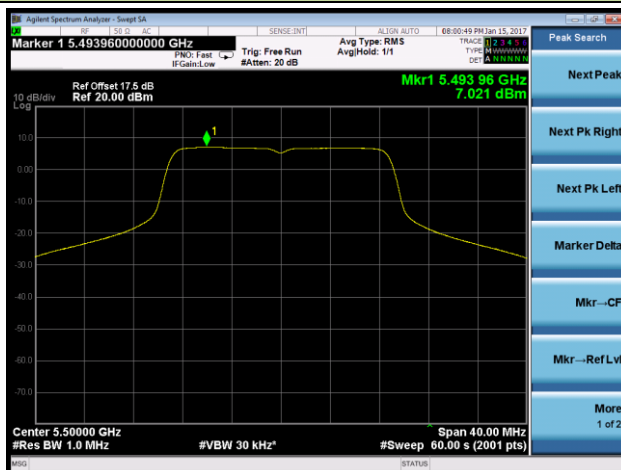

The Mask Data

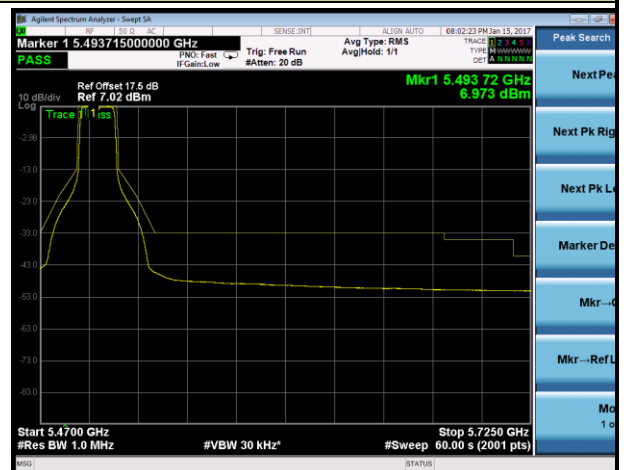

Channel 140 (5700MHz)

The Reference Level

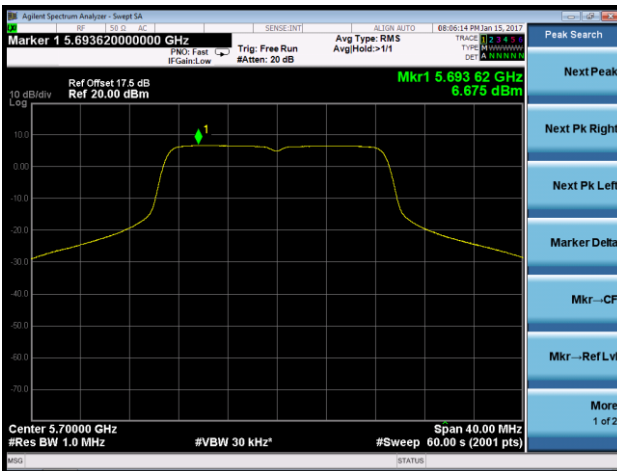

The Mask Data

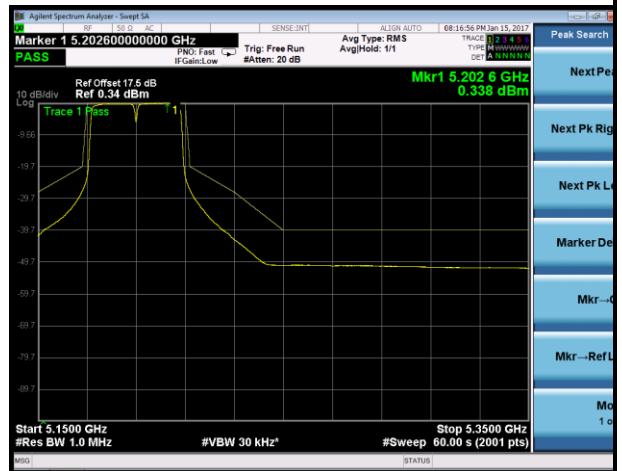

802.11ac-VHT40 Transmitter Unwanted Emissions Within the 5GHz RLAN Bands – 1Tx

Channel 38 (5190MHz)

The Reference Level

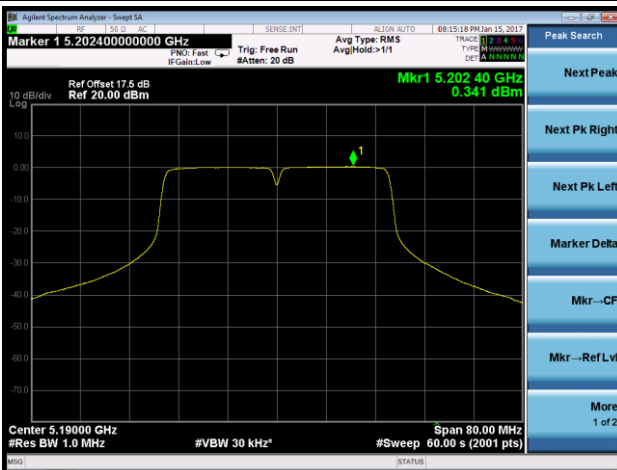

The Mask Data

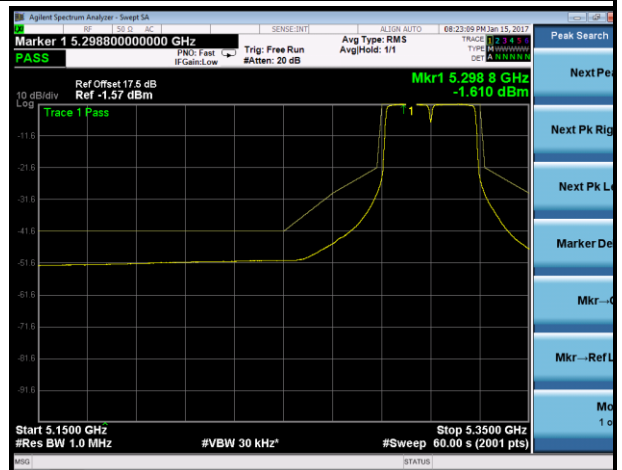

Channel 62 (5310MHz)

The Reference Level

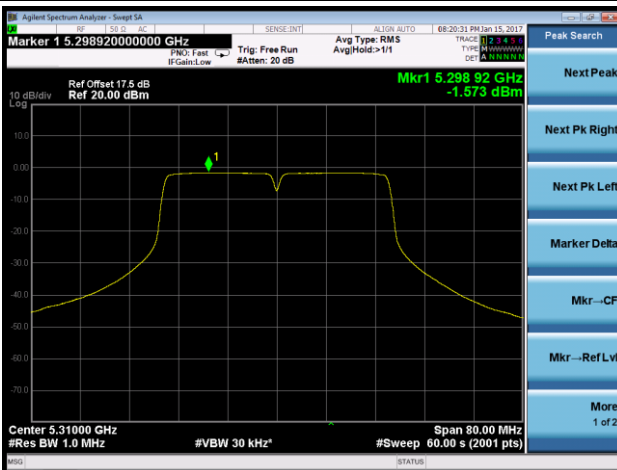

The Mask Data

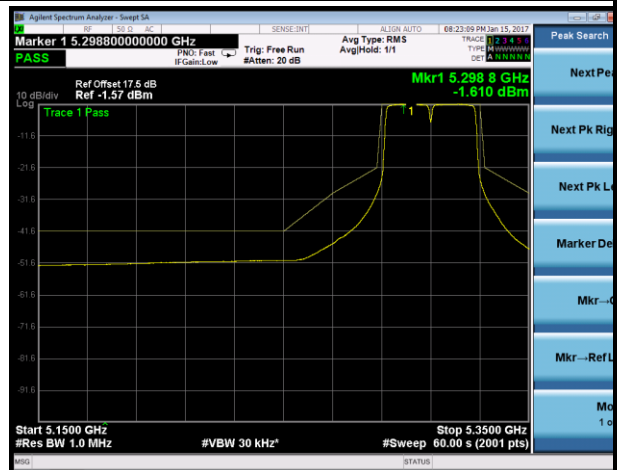

Channel 102 (5510MHz)

The Reference Level

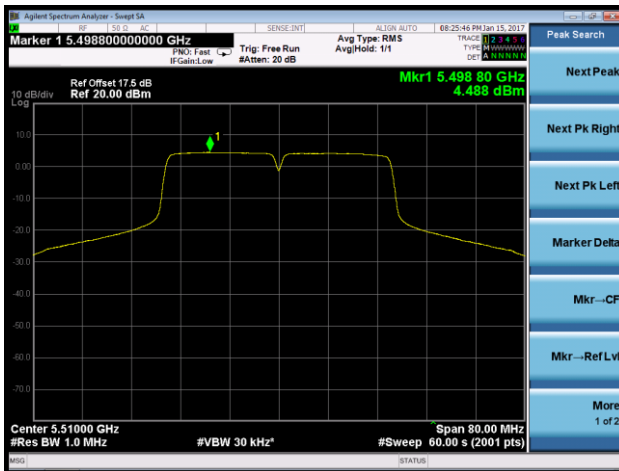

The Mask Data



Channel 134 (5670MHz)

The Reference Level

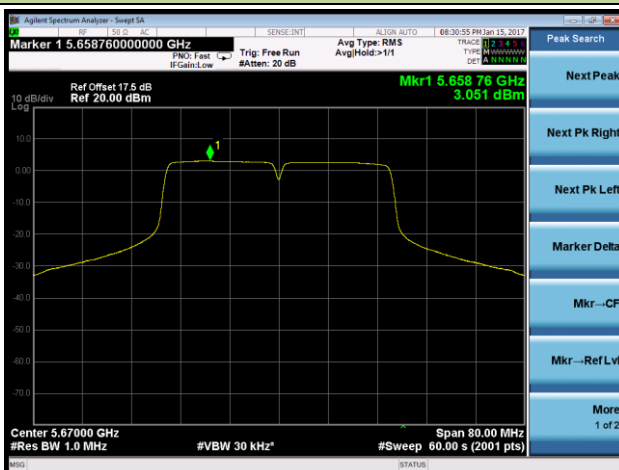

The Mask Data

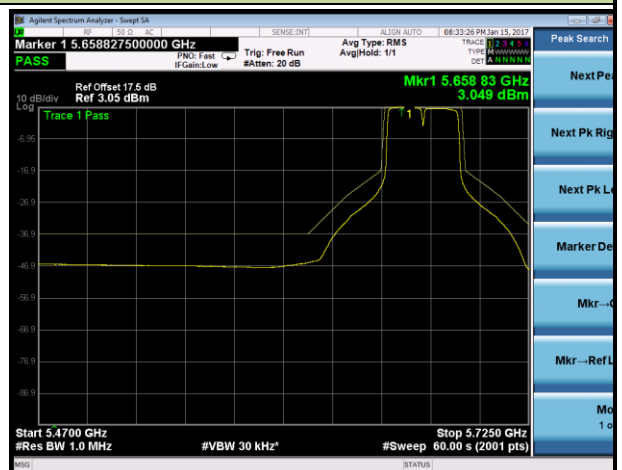

802.11ac-VHT80 Transmitter Unwanted Emissions Within the 5GHz RLAN Bands - 1Tx

Channel 42 (5210MHz)

The Reference Level

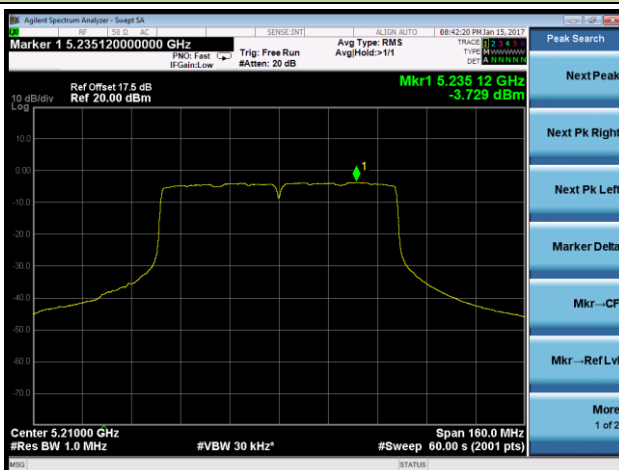

The Mask Data

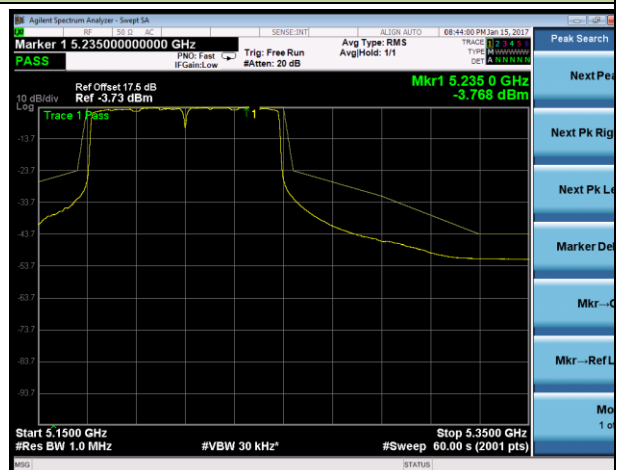

Channel 58 (5290MHz)

The Reference Level

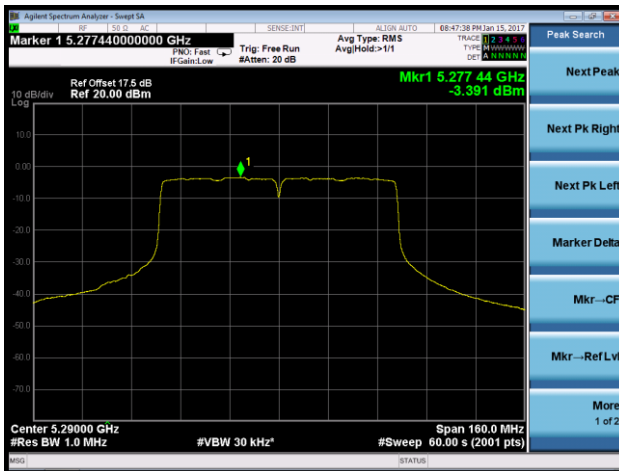

The Mask Data

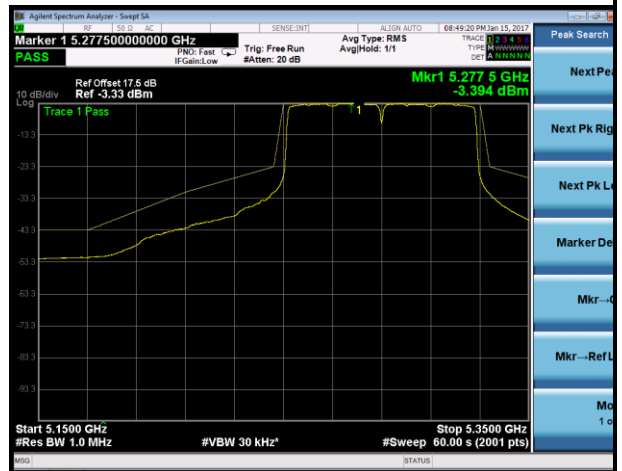

Channel 106 (5530MHz)

The Reference Level

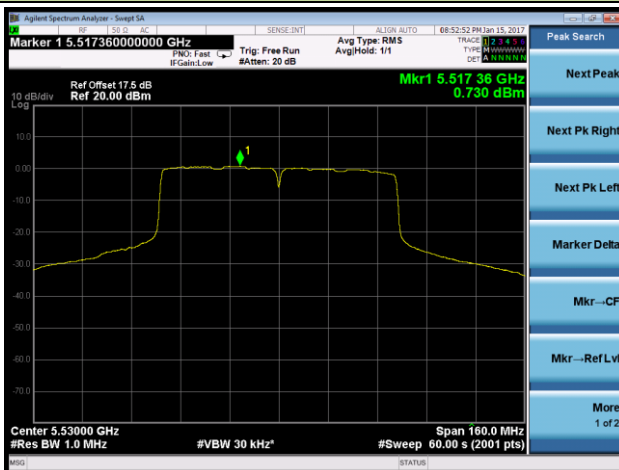

The Mask Data

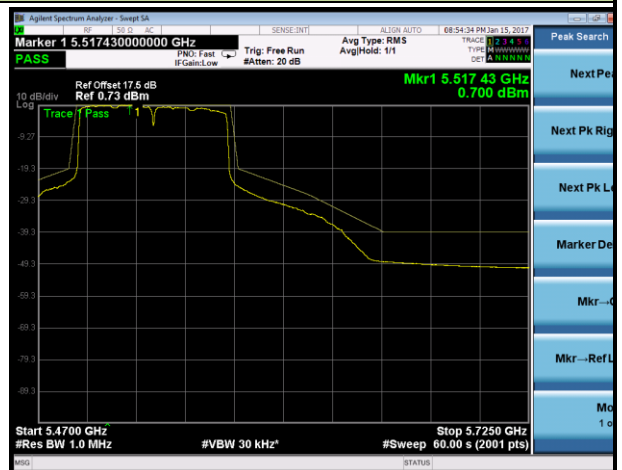

Channel 122 (5610MHz)

The Reference Level

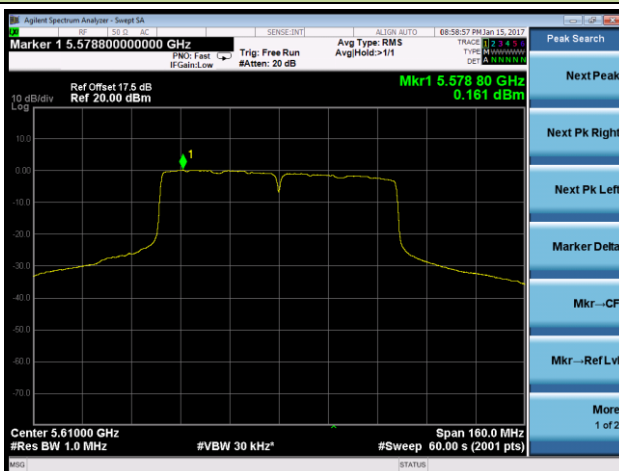

The Mask Data

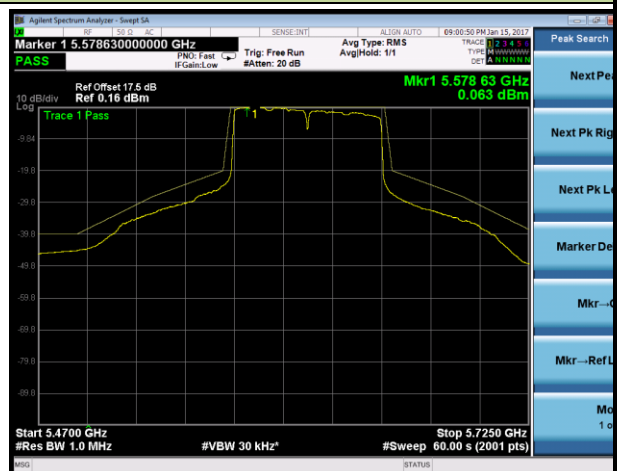

802.11n-HT20 Transmitter Unwanted Emissions Within the 5GHz RLAN Bands – 2Tx

Channel 36 (5180MHz)

The Reference Level

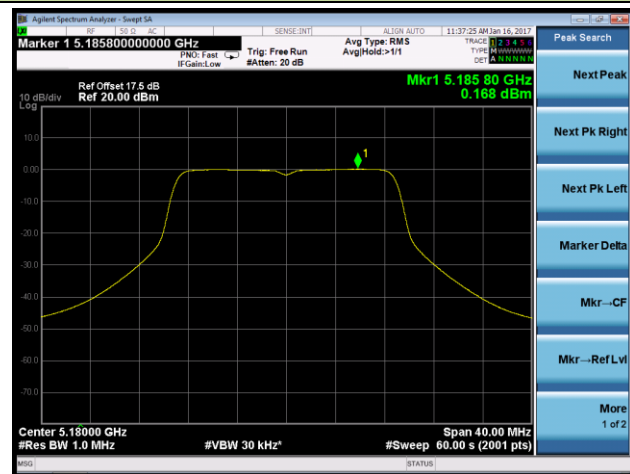

The Mask Data

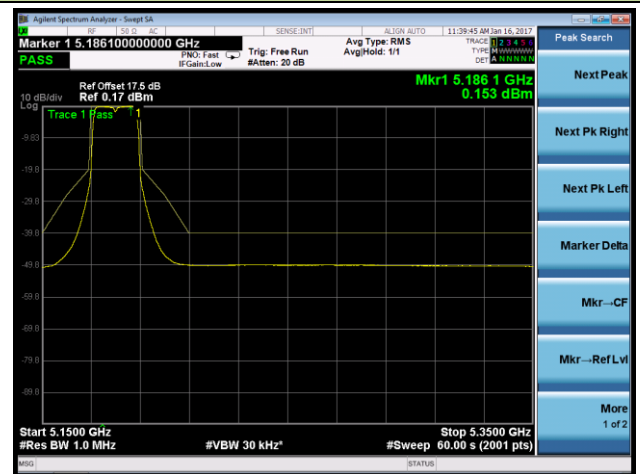

Channel 64 (5320MHz)

The Reference Level

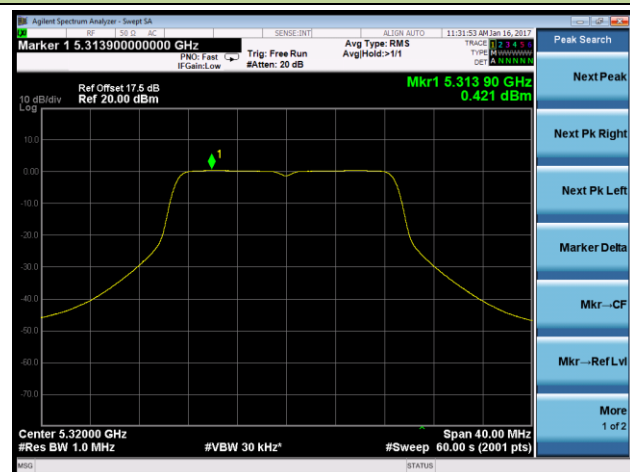

The Mask Data

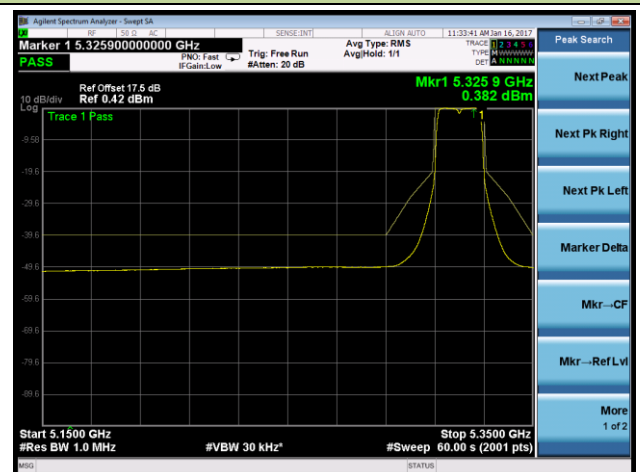

Channel 100 (5500MHz)

The Reference Level

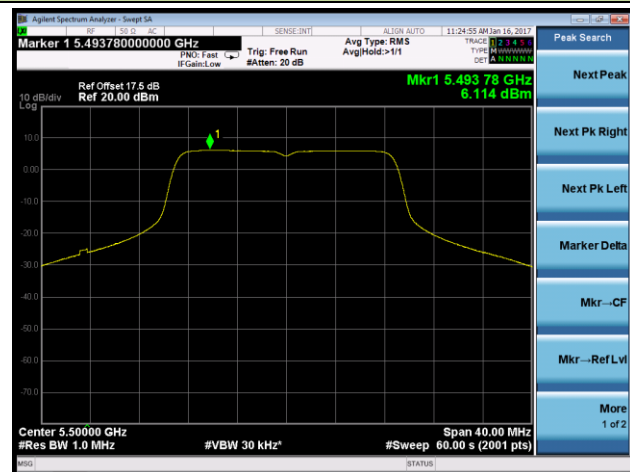

The Mask Data



Channel 140 (5700MHz)

The Reference Level

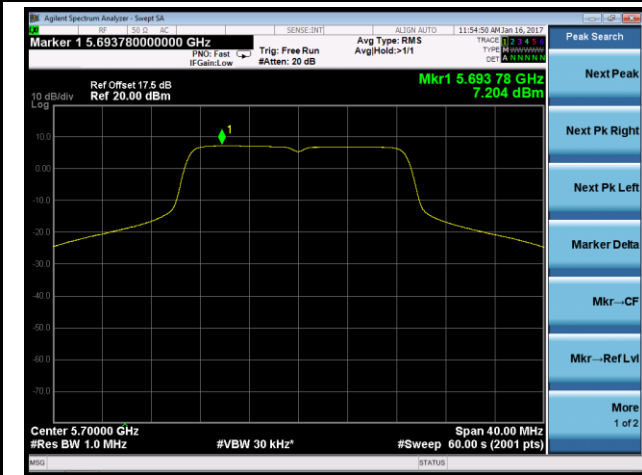

The Mask Data



802.11n-HT40 Transmitter Unwanted Emissions Within the 5GHz RLAN Bands – 2Tx

Channel 38 (5190MHz)

The Reference Level

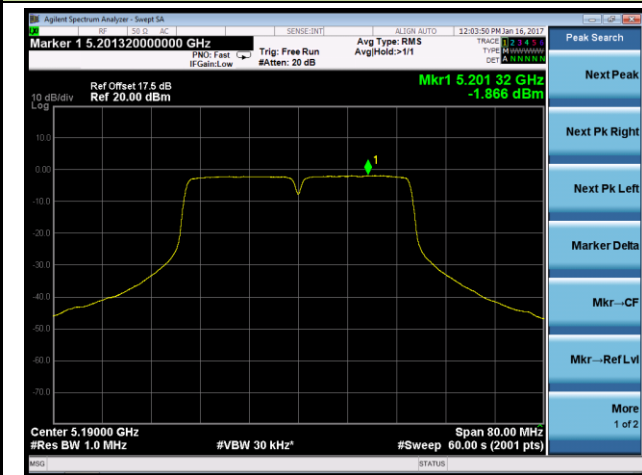

The Mask Data



Channel 62 (5310MHz)

The Reference Level

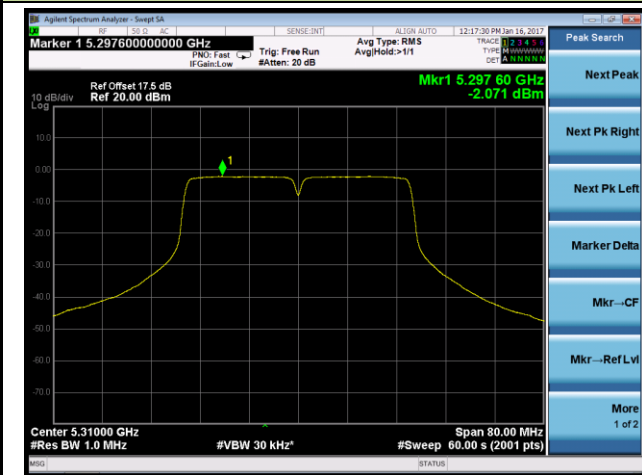

The Mask Data

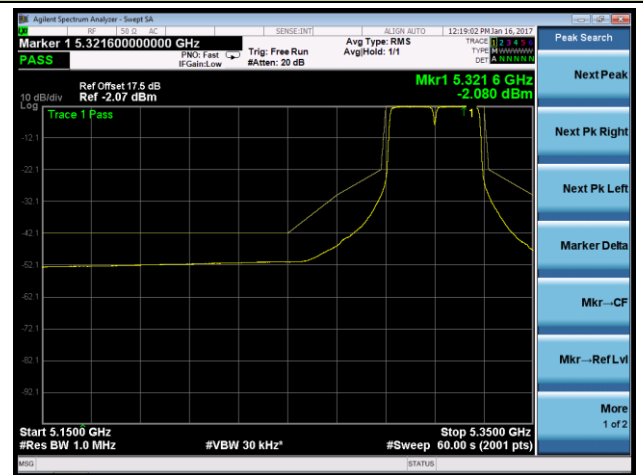

Channel 102 (5510MHz)

The Reference Level

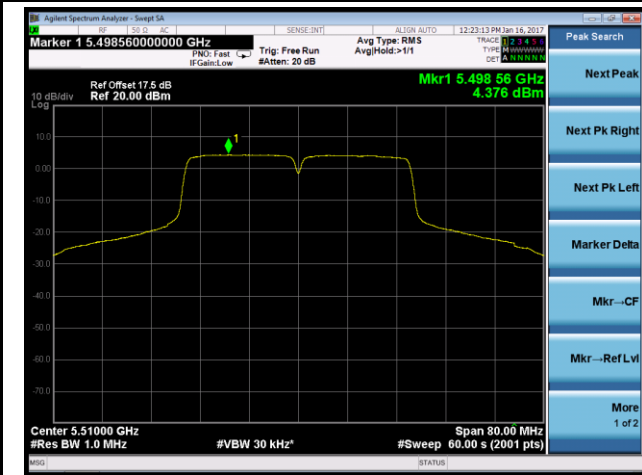

The Mask Data



Channel 134 (5670MHz)

The Reference Level

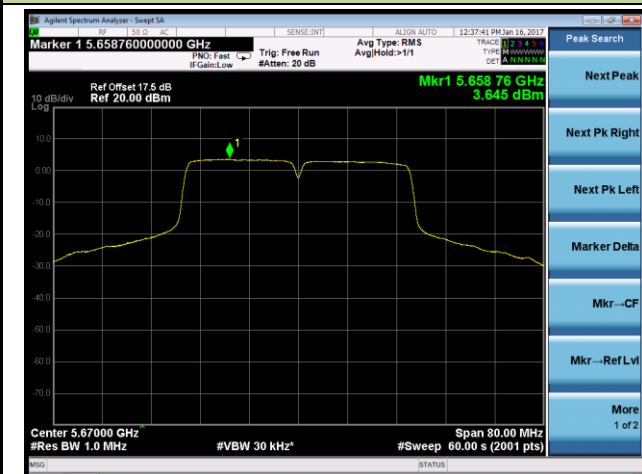

The Mask Data

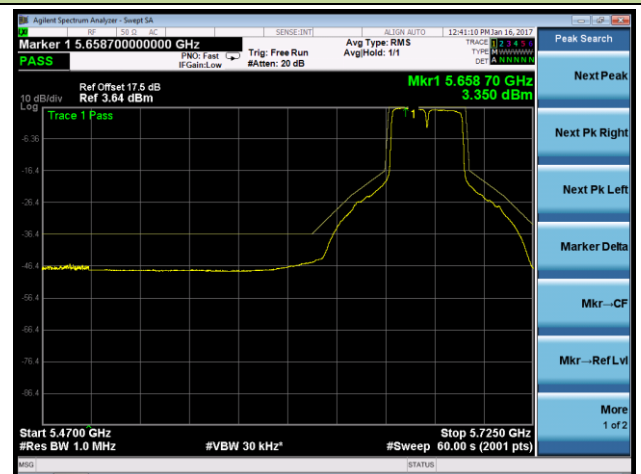

802.11ac-VHT20 Transmitter Unwanted Emissions Within the 5GHz RLAN Bands – 2Tx

Channel 36 (5180MHz)

The Reference Level

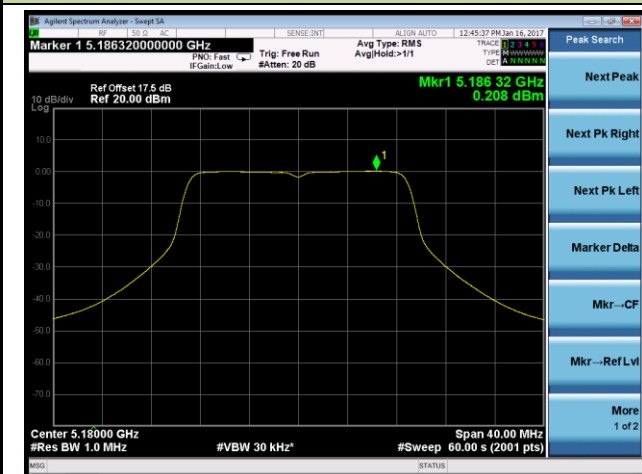

The Mask Data

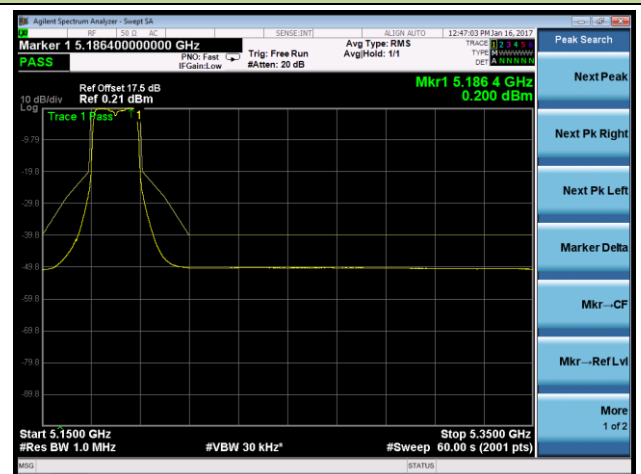

Channel 64 (5320MHz)

The Reference Level

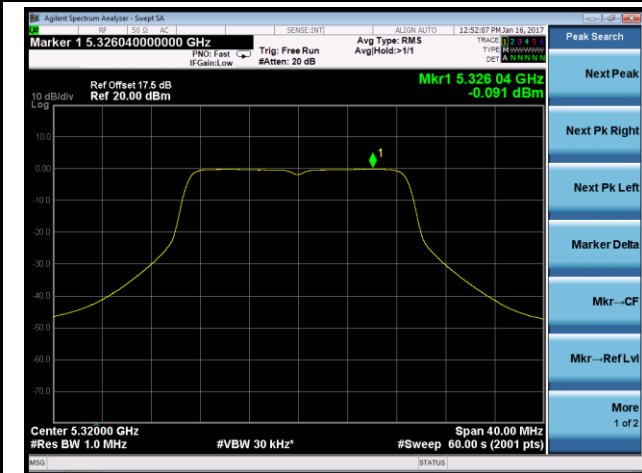

The Mask Data

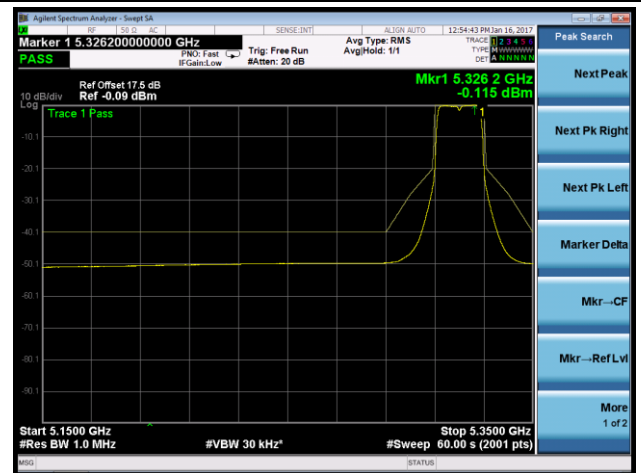

Channel 100 (5500MHz)

The Reference Level

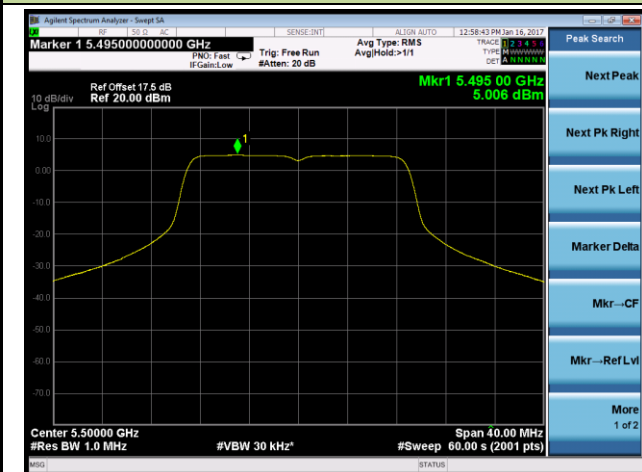

The Mask Data



Channel 140 (5700MHz)

The Reference Level

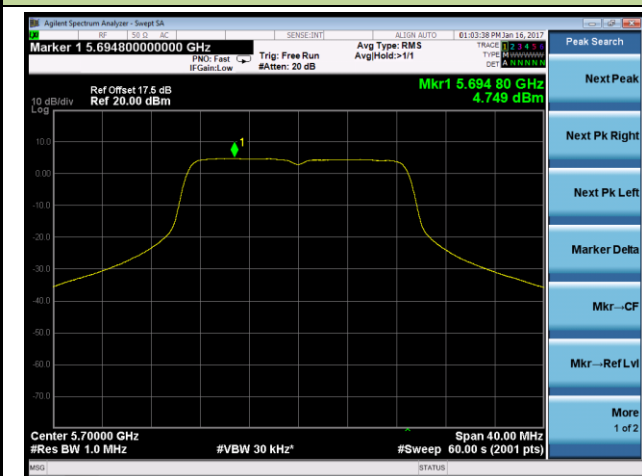

The Mask Data

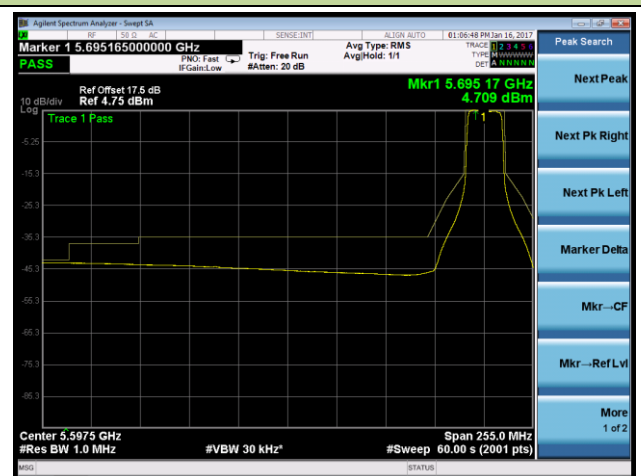

802.11ac-VHT40 Transmitter Unwanted Emissions Within the 5GHz RLAN Bands – 2Tx

Channel 38 (5190MHz)

The Reference Level

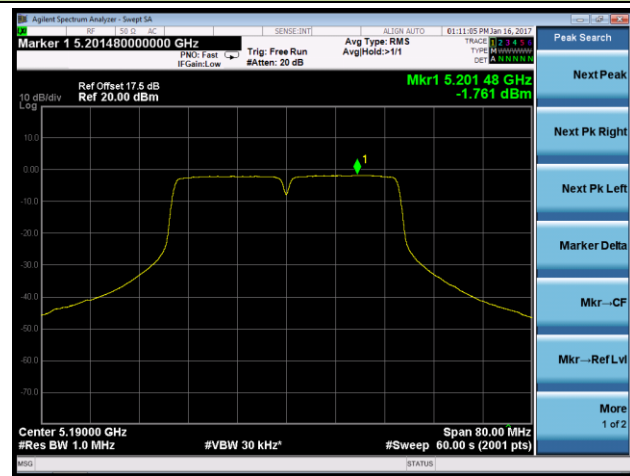

The Mask Data



Channel 62 (5310MHz)

The Reference Level

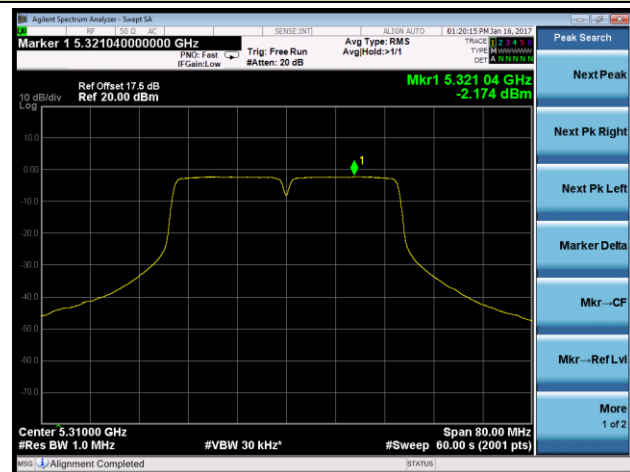

The Mask Data



Channel 102 (5510MHz)

The Reference Level

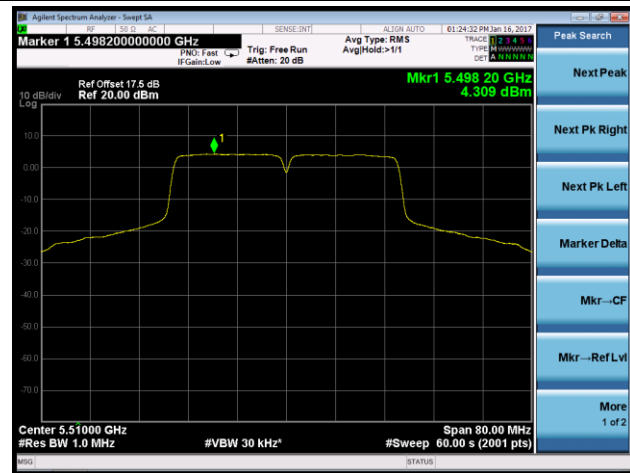

The Mask Data



Channel 134 (5670MHz)

The Reference Level

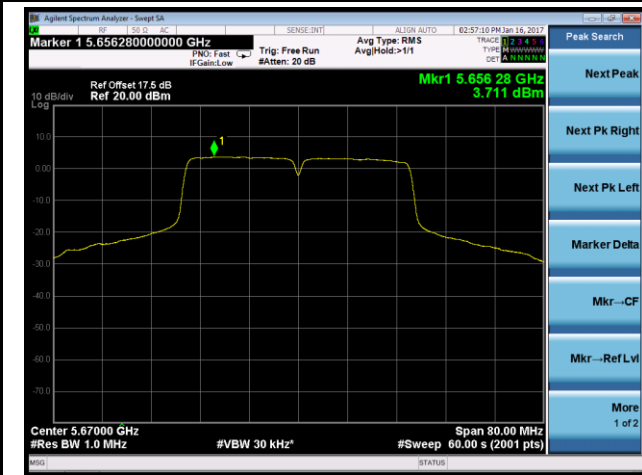

The Mask Data

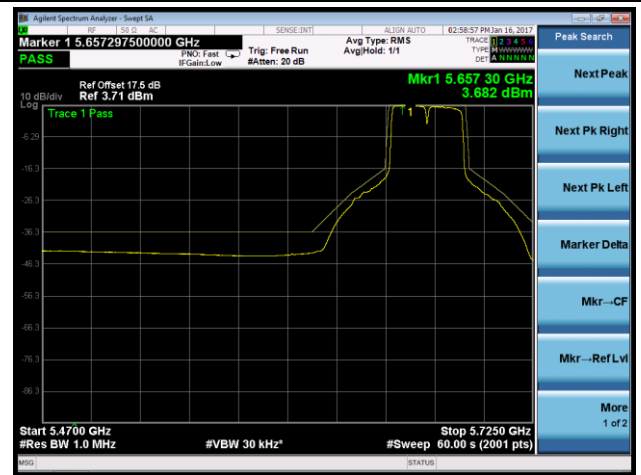

802.11ac-VHT80 Transmitter Unwanted Emissions Within the 5GHz RLAN Bands – 2Tx

Channel 42 (5210MHz)

The Reference Level

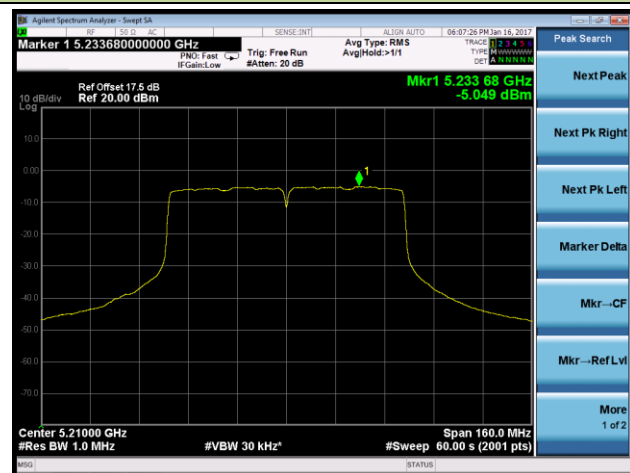

The Mask Data



Channel 58 (5290MHz)

The Reference Level

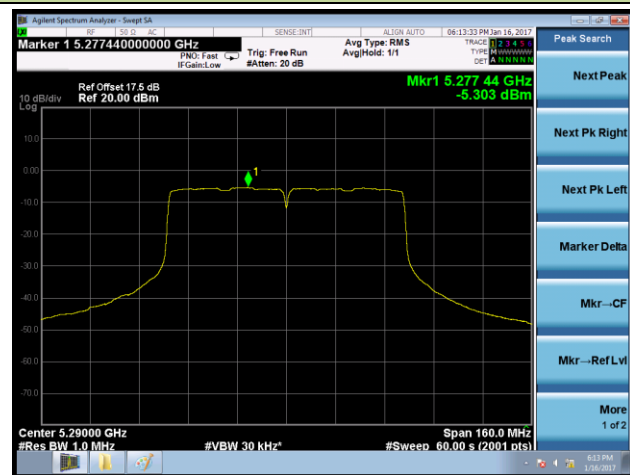

The Mask Data

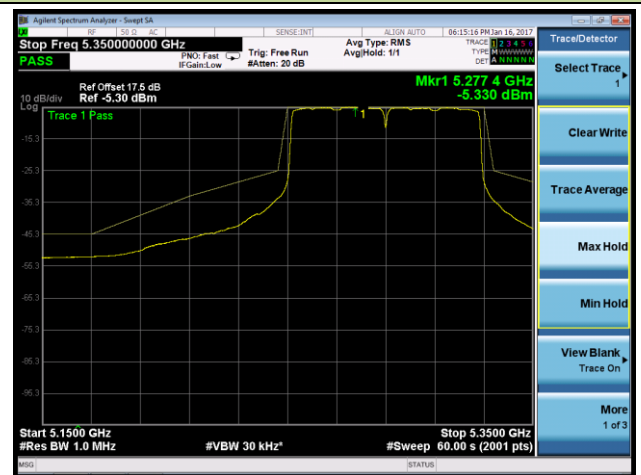

Channel 106 (5530MHz)

The Reference Level

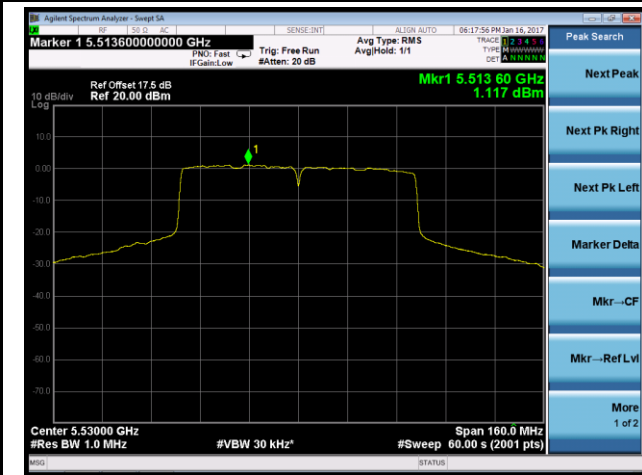

The Mask Data



Channel 122 (5610MHz)

The Reference Level

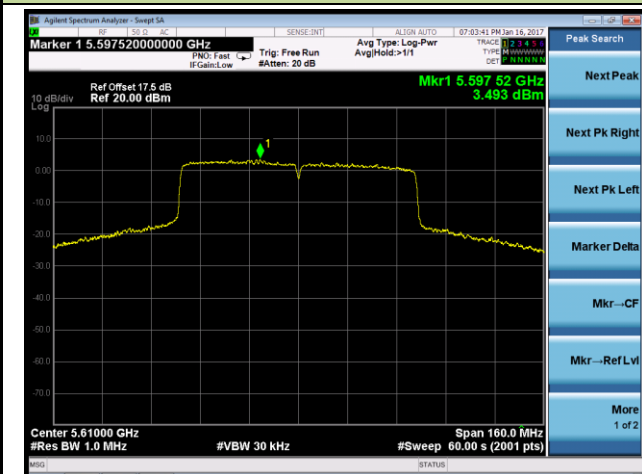

The Mask Data

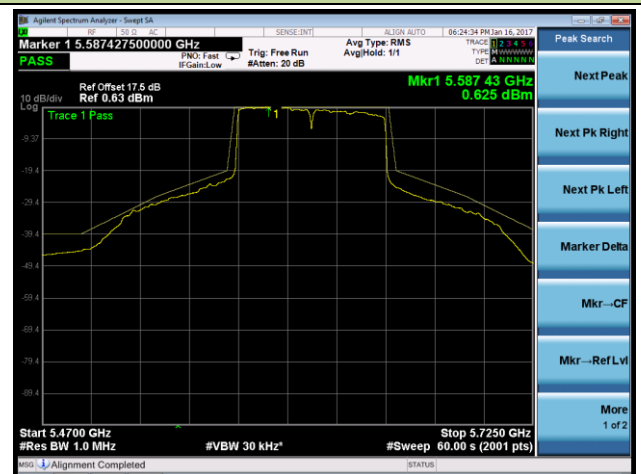

9. Receiver Spurious Emissions

9.1. Limit

Frequency Range	Maximum Power	Bandwidth
30 MHz to 1GHz	-57dBm	100 kHz
1 GHz to 26 GHz	-47dBm	1 MHz

9.2. Test Setup

Below 1GHz Test Setup:

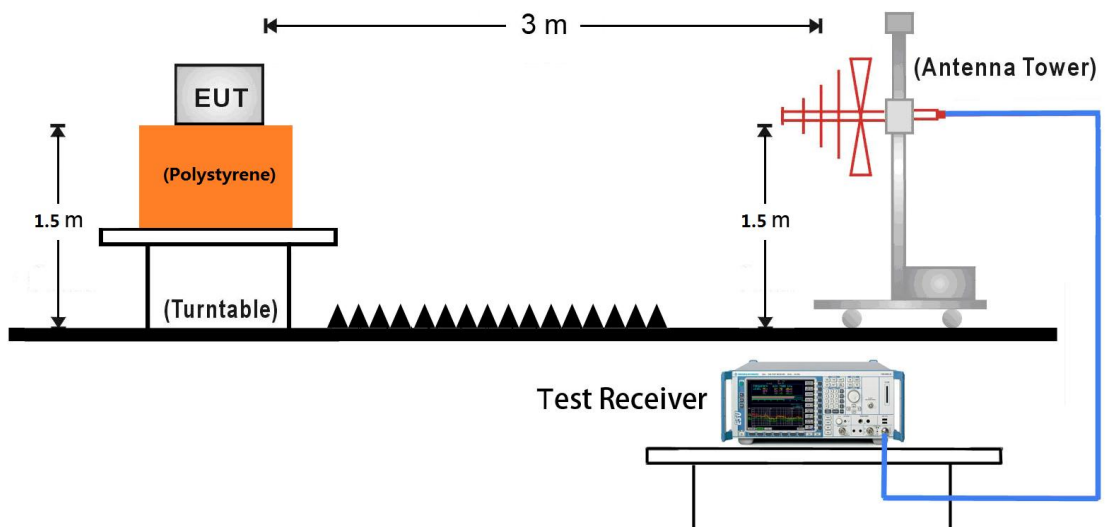

Above 1GHz Test Setup:

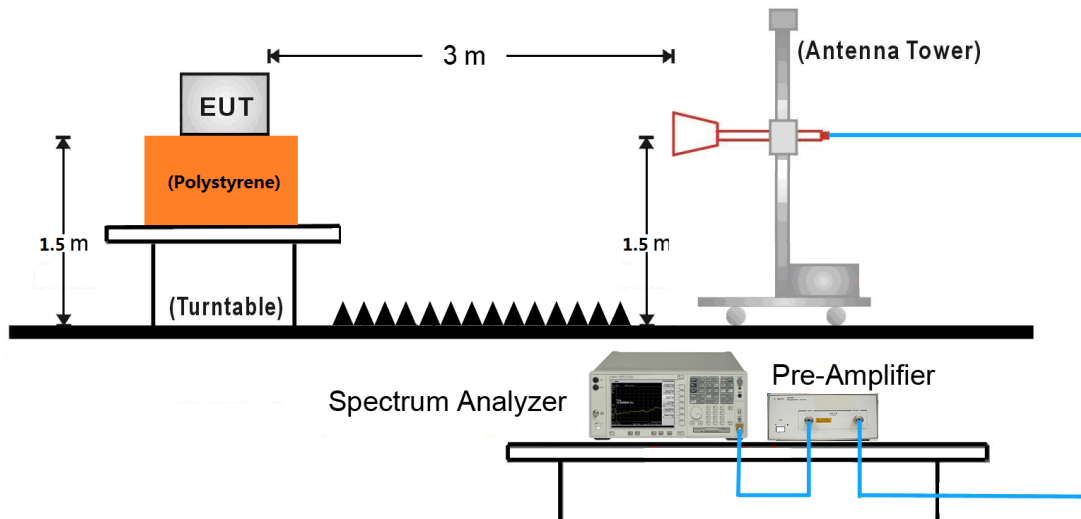

9.3. Test Procedure

Refer to ETSI EN 301 893 V1.8.1 (2015-03) Clause 5.3.7.2.2.

9.4. Test Result

Test with ANT 2#

Test Engineer	Lewis Huang	Temperature	24°C
Test Time	2016/12/24	Relative Humidity	52%
Test Mode	802.11a - Ant 1	Test Site	AC1

Channel	Frequency (MHz)	Reading Level (dBm)	Substitution Factor (dB)	Measure Level (dBm)	Limit (dBm)	Margin (dB)	Detector	Polarization
64	54.3	-89.6	23.4	-66.2	-57.0	-9.2	PK	Horizontal
	251.6	-93.6	24.9	-68.7	-57.0	-11.7	PK	Horizontal
	47.0	-91.4	21.2	-70.2	-57.0	-13.2	PK	Vertical
	115.8	-96.6	28.0	-68.6	-57.0	-11.6	PK	Vertical
	1127.5	-57.8	2.1	-55.7	-47.0	-8.7	PK	Horizontal
	2249.5	-68.6	9.5	-59.1	-47.0	-12.1	PK	Horizontal
	1348.5	-62.4	4.6	-57.8	-47.0	-10.8	PK	Vertical
	1875.5	-63.2	6.0	-57.2	-47.0	-10.2	PK	Vertical
100	59.1	-89.4	22.5	-66.9	-57.0	-9.9	PK	Horizontal
	265.2	-91.2	25.5	-65.7	-57.0	-8.7	PK	Horizontal
	53.8	-86.6	21.9	-64.7	-57.0	-7.7	PK	Vertical
	250.2	-87.4	22.1	-65.3	-57.0	-8.3	PK	Vertical
	1127.5	-56.6	2.1	-54.5	-47.0	-7.5	PK	Horizontal
	2249.5	-68.9	9.5	-59.4	-47.0	-12.4	PK	Horizontal
	1348.5	-60.6	4.6	-56.0	-47.0	-9.0	PK	Vertical
	2249.5	-67.1	9.0	-58.1	-47.0	-11.1	PK	Vertical

Note 1: Measure Level (dBm) = Reading Level (dBm) + Substitution Factor (dB)

Note 2: Substitution Factor (dB) = Cable Loss (dB) + Space Attenuation (dB) + Antenna Factor (dB/m) - Pre_Amplifier Gain (dB)

Note 3: Other frequency was base noise within 18-26.5GHz, there is not show in the report.

Test Engineer	Lewis Huang	Temperature	24°C
Test Time	2016/12/24	Relative Humidity	52%
Test Mode	802.11n-HT20 - Ant 0 + 1	Test Site	AC1

Channel	Frequency (MHz)	Reading Level (dBm)	Substitution Factor (dB)	Measure Level (dBm)	Limit (dBm)	Margin (dB)	Detector	Polarization
64	38.7	-95.8	29.8	-66.0	-57.0	-9.0	PK	Horizontal
	300.1	-89.7	23.4	-66.3	-57.0	-9.3	PK	Horizontal
	47.9	-87.6	21.1	-66.5	-57.0	-9.5	PK	Vertical
	250.2	-86.0	22.1	-63.9	-57.0	-6.9	PK	Vertical
	1127.5	-55.8	2.1	-53.7	-47.0	-6.7	PK	Horizontal
	2249.5	-67.4	9.5	-57.9	-47.0	-10.9	PK	Horizontal
	1875.5	-62.8	6.0	-56.8	-47.0	-9.8	PK	Vertical
	3805.0	-72.0	13.8	-58.2	-47.0	-11.2	PK	Vertical
100	64.9	-86.9	22.8	-64.1	-57.0	-7.1	PK	Horizontal
	93.5	-80.1	15.1	-65.0	-57.0	-8.0	PK	Horizontal
	39.2	-87.9	19.2	-68.7	-57.0	-11.7	PK	Vertical
	205.1	-87.0	21.7	-65.3	-57.0	-8.3	PK	Vertical
	1127.5	-55.5	2.1	-53.4	-47.0	-6.4	PK	Horizontal
	2249.5	-68.2	9.5	-58.7	-47.0	-11.7	PK	Horizontal
	1348.5	-59.9	4.6	-55.3	-47.0	-8.3	PK	Vertical
	2249.5	-65.7	9.0	-56.7	-47.0	-9.7	PK	Vertical

Note 1: Measure Level (dBm) = Reading Level (dBm) + Substitution Factor (dB)

Note 2: Substitution Factor (dB) = Cable Loss (dB) + Space Attenuation (dB) + Antenna Factor (dB/m) - Pre_Amplifier Gain (dB)

Note 3: Other frequency was base noise within 18-26.5GHz, there is not show in the report.

Test Engineer	Lewis Huang	Temperature	24°C
Test Time	2016/12/24	Relative Humidity	52%
Test Mode	802.11n-HT40 - Ant 0 + 1	Test Site	AC1

Channel	Frequency (MHz)	Reading Level (dBm)	Substitution Factor (dB)	Measure Level (dBm)	Limit (dBm)	Margin (dB)	Detector	Polarization
62	58.1	-87.5	22.7	-64.8	-57.0	-7.8	PK	Horizontal
	102.3	-80.9	14.9	-66.0	-57.0	-9.0	PK	Horizontal
	59.6	-86.0	22.3	-63.7	-57.0	-6.7	PK	Vertical
	125.1	-91.2	25.2	-66.0	-57.0	-9.0	PK	Vertical
	1127.5	-58.1	2.1	-56.0	-47.0	-9.0	PK	Horizontal
	2249.5	-68.3	9.5	-58.8	-47.0	-11.8	PK	Horizontal
	1348.5	-59.7	4.6	-55.1	-47.0	-8.1	PK	Vertical
	2249.5	-65.8	9.0	-56.8	-47.0	-9.8	PK	Vertical
102	58.1	-87.1	22.7	-64.4	-57.0	-7.4	PK	Horizontal
	91.6	-82.6	15.5	-67.1	-57.0	-10.1	PK	Horizontal
	59.1	-88.7	22.3	-66.4	-57.0	-9.4	PK	Vertical
	90.1	-92.0	24.9	-67.1	-57.0	-10.1	PK	Vertical
	1127.5	-55.3	2.1	-53.2	-47.0	-6.2	PK	Horizontal
	2249.5	-66.9	9.5	-57.4	-47.0	-10.4	PK	Horizontal
	1348.5	-59.2	4.6	-54.6	-47.0	-7.6	PK	Vertical
	1875.5	-62.9	6.0	-56.9	-47.0	-9.9	PK	Vertical

Note 1: Measure Level (dBm) = Reading Level (dBm) + Substitution Factor (dB)

Note 2: Substitution Factor (dB) = Cable Loss (dB) + Space Attenuation (dB) + Antenna Factor (dB/m) - Pre_Amplifier Gain (dB)

Note 3: Other frequency was base noise within 18-26.5GHz, there is not show in the report.

Test Engineer	Lewis Huang	Temperature	24°C
Test Time	2016/12/24	Relative Humidity	52%
Test Mode	802.11ac-VHT20 - Ant 0 + 1	Test Site	AC1

Channel	Frequency (MHz)	Reading Level (dBm)	Substitution Factor (dB)	Measure Level (dBm)	Limit (dBm)	Margin (dB)	Detector	Polarization
64	58.6	-89.6	22.6	-67.0	-57.0	-10.0	PK	Horizontal
	97.4	-80.0	14.7	-65.3	-57.0	-8.3	PK	Horizontal
	53.8	-87.1	21.9	-65.2	-57.0	-8.2	PK	Vertical
	125.1	-88.4	25.2	-63.2	-57.0	-6.2	PK	Vertical
	1127.5	-55.4	2.1	-53.3	-47.0	-6.3	PK	Horizontal
	2249.5	-68.6	9.5	-59.1	-47.0	-12.1	PK	Horizontal
	1348.5	-59.2	4.6	-54.6	-47.0	-7.6	PK	Vertical
	1875.5	-62.7	6.0	-56.7	-47.0	-9.7	PK	Vertical
100	59.1	-88.4	22.5	-65.9	-57.0	-8.9	PK	Horizontal
	89.2	-79.7	16.0	-63.7	-57.0	-6.7	PK	Horizontal
	73.7	-92.1	26.5	-65.6	-57.0	-8.6	PK	Vertical
	140.1	-90.1	24.2	-65.9	-57.0	-8.9	PK	Vertical
	1127.5	-55.3	2.1	-53.2	-47.0	-6.2	PK	Horizontal
	2249.5	-68.1	9.5	-58.6	-47.0	-11.6	PK	Horizontal
	1348.5	-59.2	4.6	-54.6	-47.0	-7.6	PK	Vertical
	1875.5	-62.8	6.0	-56.8	-47.0	-9.8	PK	Vertical

Note 1: Measure Level (dBm) = Reading Level (dBm) + Substitution Factor (dB)

Note 2: Substitution Factor (dB) = Cable Loss (dB) + Space Attenuation (dB) + Antenna Factor (dB/m) - Pre_Amplifier Gain (dB)

Note 3: Other frequency was base noise within 18-26.5GHz, there is not show in the report.

Test Engineer	Lewis Huang	Temperature	24°C
Test Time	2016/12/24	Relative Humidity	52%
Test Mode	802.11ac-VHT40 - Ant 0 + 1	Test Site	AC1

Channel	Frequency (MHz)	Reading Level (dBm)	Substitution Factor (dB)	Measure Level (dBm)	Limit (dBm)	Margin (dB)	Detector	Polarization
62	64.4	-88.7	22.7	-66.0	-57.0	-9.0	PK	Horizontal
	89.2	-79.8	16.0	-63.8	-57.0	-6.8	PK	Horizontal
	39.2	-86.6	19.2	-67.4	-57.0	-10.4	PK	Vertical
	64.9	-89.2	24.2	-65.0	-57.0	-8.0	PK	Vertical
	1127.5	-57.5	2.1	-55.4	-47.0	-8.4	PK	Horizontal
	2249.5	-69.9	9.5	-60.4	-47.0	-13.4	PK	Horizontal
	1348.5	-59.1	4.6	-54.5	-47.0	-7.5	PK	Vertical
	2249.5	-66.5	9.0	-57.5	-47.0	-10.5	PK	Vertical
102	39.2	-96.4	29.4	-67.0	-57.0	-10.0	PK	Horizontal
	74.6	-86.2	20.0	-66.2	-57.0	-9.2	PK	Horizontal
	59.1	-87.2	22.3	-64.9	-57.0	-7.9	PK	Vertical
	125.1	-89.0	25.2	-63.8	-57.0	-6.8	PK	Vertical
	1127.5	-59.6	2.1	-57.5	-47.0	-10.5	PK	Horizontal
	2249.5	-68.2	9.5	-58.7	-47.0	-11.7	PK	Horizontal
	1374.0	-61.8	5.7	-56.1	-47.0	-9.1	PK	Vertical
	1629.0	-62.7	4.7	-58.0	-47.0	-11.0	PK	Vertical

Note 1: Measure Level (dBm) = Reading Level (dBm) + Substitution Factor (dB)

Note 2: Substitution Factor (dB) = Cable Loss (dB) + Space Attenuation (dB) + Antenna Factor (dB/m) - Pre_Amplifier Gain (dB)

Note 3: Other frequency was base noise within 18-26.5GHz, there is not show in the report.

Test Engineer	Lewis Huang	Temperature	24°C
Test Time	2016/12/24	Relative Humidity	52%
Test Mode	802.11ac-VHT80 - Ant 0 + 1	Test Site	AC1

Channel	Frequency (MHz)	Reading Level (dBm)	Substitution Factor (dB)	Measure Level (dBm)	Limit (dBm)	Margin (dB)	Detector	Polarization
62	62.0	-89.2	22.9	-66.3	-57.0	-9.3	PK	Horizontal
	225.0	-92.0	26.4	-65.6	-57.0	-8.6	PK	Horizontal
	53.8	-85.4	21.9	-63.5	-57.0	-6.5	PK	Vertical
	264.7	-88.5	24.3	-64.2	-57.0	-7.2	PK	Vertical
	1127.5	-59.1	2.1	-57.0	-47.0	-10.0	PK	Horizontal
	2249.5	-69.9	9.5	-60.4	-47.0	-13.4	PK	Horizontal
	1348.5	-61.1	4.6	-56.5	-47.0	-9.5	PK	Vertical
	1875.5	-62.8	6.0	-56.8	-47.0	-9.8	PK	Vertical
102	59.1	-86.1	22.5	-63.6	-57.0	-6.6	PK	Horizontal
	100.3	-80.1	14.7	-65.4	-57.0	-8.4	PK	Horizontal
	58.6	-87.2	22.3	-64.9	-57.0	-7.9	PK	Vertical
	96.4	-88.1	23.8	-64.3	-57.0	-7.3	PK	Vertical
	1127.5	-59.5	2.1	-57.4	-47.0	-10.4	PK	Horizontal
	2249.5	-67.3	9.5	-57.8	-47.0	-10.8	PK	Horizontal
	1348.5	-60.0	4.6	-55.4	-47.0	-8.4	PK	Vertical
	1875.5	-62.6	6.0	-56.6	-47.0	-9.6	PK	Vertical

Note 1: Measure Level (dBm) = Reading Level (dBm) + Substitution Factor (dB)

Note 2: Substitution Factor (dB) = Cable Loss (dB) + Space Attenuation (dB) + Antenna Factor (dB/m) - Pre_Amplifier Gain (dB)

Note 3: Other frequency was base noise within 18-26.5GHz, there is not show in the report.

Test with ANT 2#

Test Engineer	Lewis Huang	Temperature	24°C
Test Time	2016/12/24	Relative Humidity	52%
Test Mode	802.11a Ant 1	Test Site	AC2

Channel	Frequency (MHz)	Reading Level (dBm)	Substitution Factor (dB)	Measure Level (dBm)	Limit (dBm)	Margin (dB)	Detector	Polarization
64	64.7	-90.4	20.5	-69.9	-57	-12.9	PK	Horizontal
	339.2	-90.0	25.9	-64.1	-57	-7.1	PK	Horizontal
	339.2	-95.0	25.8	-69.2	-57	-12.2	PK	Vertical
	499.3	-98.2	29.3	-68.9	-57	-11.9	PK	Vertical
	3753.3	-62.3	11.9	-50.4	-47	-3.4	PK	Horizontal
	5121.8	-69.2	16.0	-53.2	-47	-6.2	PK	Horizontal
	2240.3	-66.2	10.0	-56.2	-47	-9.2	PK	Vertical
	3753.3	-66.1	12.6	-53.5	-47	-6.5	PK	Vertical
100	65.2	-90.9	20.4	-70.5	-57	-13.5	PK	Horizontal
	339.2	-90.0	25.9	-64.1	-57	-7.1	PK	Horizontal
	88.5	-97.2	30.5	-66.7	-57	-9.7	PK	Vertical
	339.2	-95.4	25.8	-69.6	-57	-12.6	PK	Vertical
	3753.3	-61.8	11.9	-49.9	-47	-2.9	PK	Horizontal
	4433.3	-68.1	14.1	-54.0	-47	-7.0	PK	Horizontal
	3753.3	-65.3	12.6	-52.7	-47	-5.7	PK	Vertical
	5002.8	-68.1	16.5	-51.6	-47	-4.6	PK	Vertical

Note 1: Measure Level (dBm) = Reading Level (dBm) + Substitution Factor (dB)

Note 2: Substitution Factor (dB) = Cable Loss (dB) + Space Attenuation (dB) + Antenna Factor (dB/m) - Pre_Amplifier Gain (dB)

Note 3: Other frequency was base noise within 18-26.5GHz, there is not show in the report.

Test Engineer	Lewis Huang	Temperature	24°C
Test Time	2016/12/24	Relative Humidity	52%
Test Mode	802.11n-HT20 – Ant 0 + 1	Test Site	AC2

Channel	Frequency (MHz)	Reading Level (dBm)	Substitution Factor (dB)	Measure Level (dBm)	Limit (dBm)	Margin (dB)	Detector	Polarization
64	64.7	-88.8	20.5	-68.3	-57	-11.3	PK	Horizontal
	339.2	-88.6	25.9	-62.7	-57	-5.7	PK	Horizontal
	66.6	-88.3	21.9	-66.4	-57	-9.4	PK	Vertical
	339.2	-95.0	25.8	-69.2	-57	-12.2	PK	Vertical
	2240.3	-66.6	9.8	-56.8	-47	-9.8	PK	Horizontal
	3753.3	-61.8	11.9	-49.9	-47	-2.9	PK	Horizontal
	1679.3	-65.8	6.3	-59.5	-47	-12.5	PK	Vertical
	3753.3	-67.0	12.6	-54.4	-47	-7.4	PK	Vertical
100	68.6	-91.0	19.9	-71.1	-57	-14.1	PK	Horizontal
	339.2	-89.9	25.9	-64.0	-57	-7.0	PK	Horizontal
	93.3	-100.0	33.2	-66.8	-57	-9.8	PK	Vertical
	339.2	-97.1	25.8	-71.3	-57	-14.3	PK	Vertical
	2240.3	-66.8	9.8	-57.0	-47	-10.0	PK	Horizontal
	3753.3	-62.3	11.9	-50.4	-47	-3.4	PK	Horizontal
	2240.3	-67.2	10.0	-57.2	-47	-10.2	PK	Vertical
	3753.3	-66.6	12.6	-54.0	-47	-7.0	PK	Vertical

Note 1: Measure Level (dBm) = Reading Level (dBm) + Substitution Factor (dB)

Note 2: Substitution Factor (dB) = Cable Loss (dB) + Space Attenuation (dB) + Antenna Factor (dB/m) - Pre_Amplifier Gain (dB)

Note 3: Other frequency was base noise within 18-26.5GHz, there is not show in the report.

Test Engineer	Lewis Huang	Temperature	24°C
Test Time	2016/12/24	Relative Humidity	52%
Test Mode	802.11n-HT40 – Ant 0 + 1	Test Site	AC2

Channel	Frequency (MHz)	Reading Level (dBm)	Substitution Factor (dB)	Measure Level (dBm)	Limit (dBm)	Margin (dB)	Detector	Polarization
60	339.2	-90.2	25.9	-64.3	-57	-7.3	PK	Horizontal
	579.3	-95.8	31.2	-64.6	-57	-7.6	PK	Horizontal
	63.7	-90.0	22.5	-67.5	-57	-10.5	PK	Vertical
	339.2	-96.5	25.8	-70.7	-57	-13.7	PK	Vertical
	1245.8	-66.2	8.1	-58.1	-47	-11.1	PK	Horizontal
	3753.3	-61.7	11.9	-49.8	-47	-2.8	PK	Horizontal
	1245.8	-64.9	7.9	-57.0	-47	-10.0	PK	Vertical
	2240.3	-66.9	10.0	-56.9	-47	-9.9	PK	Vertical
100	65.2	-90.6	20.4	-70.2	-57	-13.2	PK	Horizontal
	579.3	-95.3	31.2	-64.1	-57	-7.1	PK	Horizontal
	68.1	-89.2	22.0	-67.2	-57	-10.2	PK	Vertical
	579.3	-96.9	30.9	-66.0	-57	-9.0	PK	Vertical
	2240.3	-66.5	9.8	-56.7	-47	-9.7	PK	Horizontal
	3753.3	-62.2	11.9	-50.3	-47	-3.3	PK	Horizontal
	1245.8	-64.6	7.9	-56.7	-47	-9.7	PK	Vertical
	3753.3	-66.8	12.6	-54.2	-47	-7.2	PK	Vertical

Note 1: Measure Level (dBm) = Reading Level (dBm) + Substitution Factor (dB)

Note 2: Substitution Factor (dB) = Cable Loss (dB) + Space Attenuation (dB) + Antenna Factor (dB/m) - Pre_Amplifier Gain (dB)

Note 3: Other frequency was base noise within 18-26.5GHz, there is not show in the report.

Test Engineer	Lewis Huang	Temperature	24°C
Test Time	2016/12/24	Relative Humidity	52%
Test Mode	802.11ac-VHT20 – Ant 0 + 1	Test Site	AC2

Channel	Frequency (MHz)	Reading Level (dBm)	Substitution Factor (dB)	Measure Level (dBm)	Limit (dBm)	Margin (dB)	Detector	Polarization
64	69.1	-90.9	19.7	-71.2	-57	-14.2	PK	Horizontal
	339.2	-90.7	25.9	-64.8	-57	-7.8	PK	Horizontal
	90.9	-97.0	30.7	-66.3	-57	-9.3	PK	Vertical
	339.2	-95.7	25.8	-69.9	-57	-12.9	PK	Vertical
	1398.8	-62.7	7.1	-55.6	-47	-8.6	PK	Horizontal
	3753.3	-61.7	11.9	-49.8	-47	-2.8	PK	Horizontal
	2240.3	-67.2	10.0	-57.2	-47	-10.2	PK	Vertical
	3753.3	-66.4	12.6	-53.8	-47	-6.8	PK	Vertical
100	66.6	-90.0	20.2	-69.8	-57	-12.8	PK	Horizontal
	339.2	-90.0	25.9	-64.1	-57	-7.1	PK	Horizontal
	90.4	-97.9	30.6	-67.3	-57	-10.3	PK	Vertical
	339.2	-94.9	25.8	-69.1	-57	-12.1	PK	Vertical
	1398.8	-61.4	7.1	-54.3	-47	-7.3	PK	Horizontal
	3753.3	-61.9	11.9	-50.0	-47	-3.0	PK	Horizontal
	2240.3	-67.0	10.0	-57.0	-47	-10.0	PK	Vertical
	3753.3	-66.8	12.6	-54.2	-47	-7.2	PK	Vertical

Note 1: Measure Level (dBm) = Reading Level (dBm) + Substitution Factor (dB)

Note 2: Substitution Factor (dB) = Cable Loss (dB) + Space Attenuation (dB) + Antenna Factor (dB/m) - Pre_Amplifier Gain (dB)

Note 3: Other frequency was base noise within 18-26.5GHz, there is not show in the report.

Test Engineer	Lewis Huang	Temperature	24°C
Test Time	2016/12/24	Relative Humidity	52%
Test Mode	802.11ac-VHT40 – Ant 0 + 1	Test Site	AC2

Channel	Frequency (MHz)	Reading Level (dBm)	Substitution Factor (dB)	Measure Level (dBm)	Limit (dBm)	Margin (dB)	Detector	Polarization
64	68.1	-89.9	20.0	-69.9	-57	-12.9	PK	Horizontal
	339.2	-90.2	25.9	-64.3	-57	-7.3	PK	Horizontal
	90.9	-97.5	30.7	-66.8	-57	-9.8	PK	Vertical
	499.3	-97.3	29.3	-68.0	-57	-11.0	PK	Vertical
	2240.3	-66.7	9.8	-56.9	-47	-9.9	PK	Horizontal
	3753.3	-62.3	11.9	-50.4	-47	-3.4	PK	Horizontal
	2240.3	-67.1	10.0	-57.1	-47	-10.1	PK	Vertical
	3753.3	-66.0	12.6	-53.4	-47	-6.4	PK	Vertical
100	64.7	-89.5	20.5	-69.0	-57	-12.0	PK	Horizontal
	339.2	-90.6	25.9	-64.7	-57	-7.7	PK	Horizontal
	87.0	-97.0	30.3	-66.7	-57	-9.7	PK	Vertical
	339.2	-96.5	25.8	-70.7	-57	-13.7	PK	Vertical
	2240.3	-66.0	9.8	-56.2	-47	-9.2	PK	Horizontal
	3753.3	-62.0	11.9	-50.1	-47	-3.1	PK	Horizontal
	2240.3	-66.1	10.0	-56.1	-47	-9.1	PK	Vertical
	3753.3	-67.0	12.6	-54.4	-47	-7.4	PK	Vertical

Note 1: Measure Level (dBm) = Reading Level (dBm) + Substitution Factor (dB)

Note 2: Substitution Factor (dB) = Cable Loss (dB) + Space Attenuation (dB) + Antenna Factor (dB/m) - Pre_Amplifier Gain (dB)

Note 3: Other frequency was base noise within 18-26.5GHz, there is not show in the report.

Test Engineer	Lewis Huang	Temperature	24°C
Test Time	2016/12/24	Relative Humidity	52%
Test Mode	802.11ac-VHT80 – Ant 0 + 1	Test Site	AC2

Channel	Frequency (MHz)	Reading Level (dBm)	Substitution Factor (dB)	Measure Level (dBm)	Limit (dBm)	Margin (dB)	Detector	Polarization
60	339.2	-91.0	25.9	-65.1	-57	-8.1	PK	Horizontal
	579.3	-95.2	31.2	-64.0	-57	-7.0	PK	Horizontal
	64.2	-89.9	22.3	-67.6	-57	-10.6	PK	Vertical
	89.9	-97.6	30.5	-67.1	-57	-10.1	PK	Vertical
	1398.8	-62.8	7.1	-55.7	-47	-8.7	PK	Horizontal
	3753.3	-63.9	11.9	-52.0	-47	-5.0	PK	Horizontal
	2240.3	-67.3	10.0	-57.3	-47	-10.3	PK	Vertical
	3753.3	-66.3	12.6	-53.7	-47	-6.7	PK	Vertical
100	66.2	-89.9	20.3	-69.6	-57	-12.6	PK	Horizontal
	339.2	-90.0	25.9	-64.1	-57	-7.1	PK	Horizontal
	65.2	-89.0	21.9	-67.1	-57	-10.1	PK	Vertical
	579.3	-97.8	30.9	-66.9	-57	-9.9	PK	Vertical
	2240.3	-67.3	9.8	-57.5	-47	-10.5	PK	Horizontal
	3753.3	-61.8	11.9	-49.9	-47	-2.9	PK	Horizontal
	1679.3	-65.5	6.3	-59.2	-47	-12.2	PK	Vertical
	3753.3	-67.3	12.6	-54.7	-47	-7.7	PK	Vertical

Note 1: Measure Level (dBm) = Reading Level (dBm) + Substitution Factor (dB)

Note 2: Substitution Factor (dB) = Cable Loss (dB) + Space Attenuation (dB) + Antenna Factor (dB/m) - Pre_Amplifier Gain (dB)

Note 3: Other frequency was base noise within 18-26.5GHz, there is not show in the report.

10. Adaptivity (Channel Access Mechanism)

10.1. Limit

LBT based Detect and Avoid (Load based Equipment may implement an LBT based spectrum sharing mechanism as described in IEEE 802.11-2012, clauses 9, clauses 10, clauses 18 and 20 or as described in IEEE 802.11ac-2013, clauses 8, clauses 9, clause 10 and 22)

Adaptivity Limit (Option B)

The CCA observation time shall be not less than 20 us, and the CCA time used by the equipment shall be declared by the manufacturer.

The Channel Occupancy Time shall be less than $(13 / 32) * q$ ms, $q = [4 \sim 32]$.

The minimum idle period varied between CCA and $q * CCA$.

When adding the interference signal, the EUT shall stop transmissions on the current operating channel.

Short Control Signalling Transmissions Limit

Short Control Signalling Transmissions shall have a maximum duty cycle of 5% within an observation period of 50ms.

10.2. Test Setup

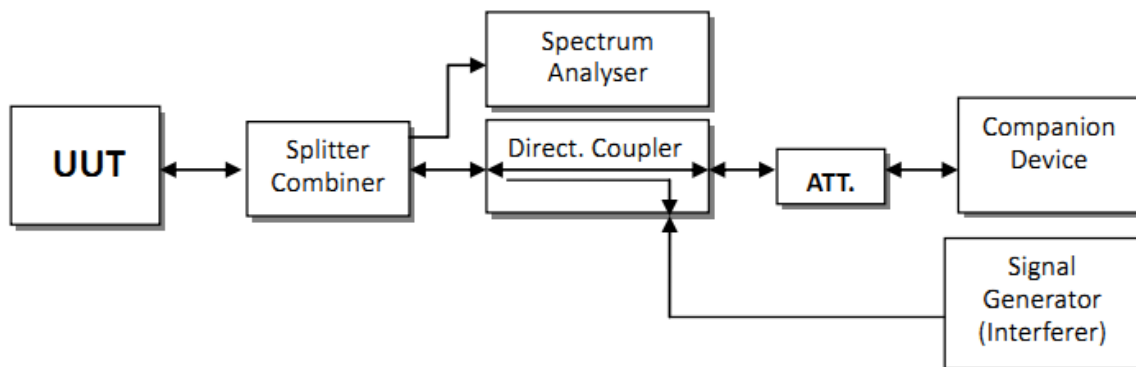

10.3. Test Procedure

Refer to ETSI EN 301 893 V1.8.1 (2015-03) Clause 5.3.9.2.1.

10.4. Test Result

Product	802.11ac Dual Band Module	Temperature	24°C
Test Engineer	Andy Zhu	Relative Humidity	54%
Test Site	TR3	Test Date	2017/01/10

The CCA observation time was 25 us, and the maximum factor of $q = 24$ which were declared by the supplier. So the idle period varied between 25 us and 600 us and the channel occupancy time shall less than $(13 / 32) * 24 = 9.75$ ms.

802.11ac-VHT80 – 5290MHz	
Maximum Channel Occupancy Time = 747.8us	Minimum Idle Period = 65.77us
Interference Signal Calibration	Transmission stopped after interference added and the short control signaling less than 5ms.

Note: Detection Level = $-73 \text{ dBm/MHz} + (23 \text{ dBm} - \text{the max conducted power (dBm)})/\text{MHz} \geq -73 \text{ dBm/MHz}$ We used the worst-case detection level (-73dBm/MHz) to perform Run adaptivity testing.

Test Result:	Pass
--------------	------

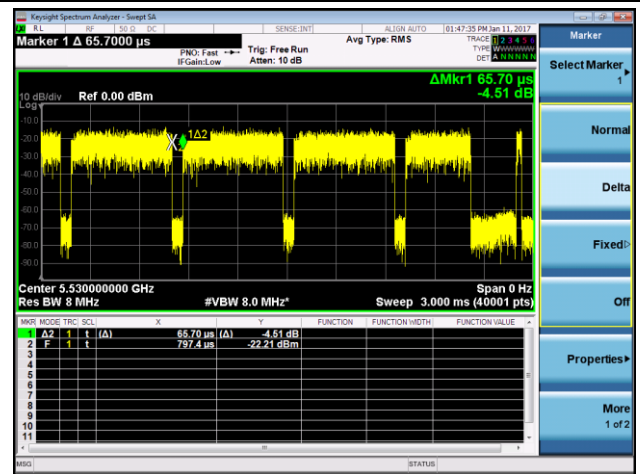
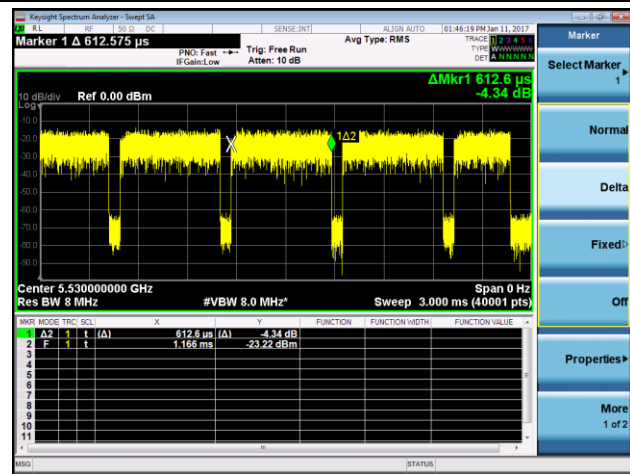
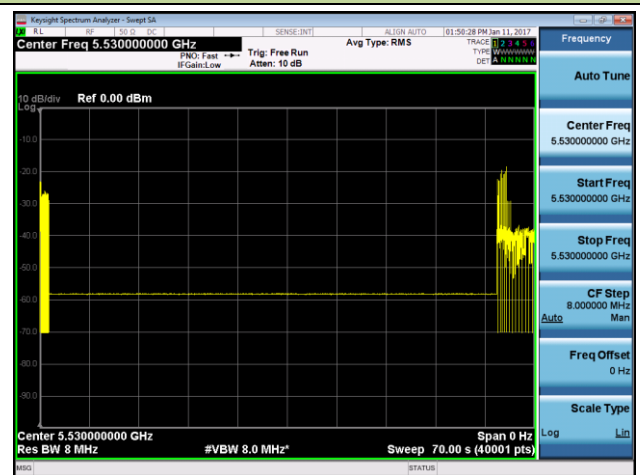
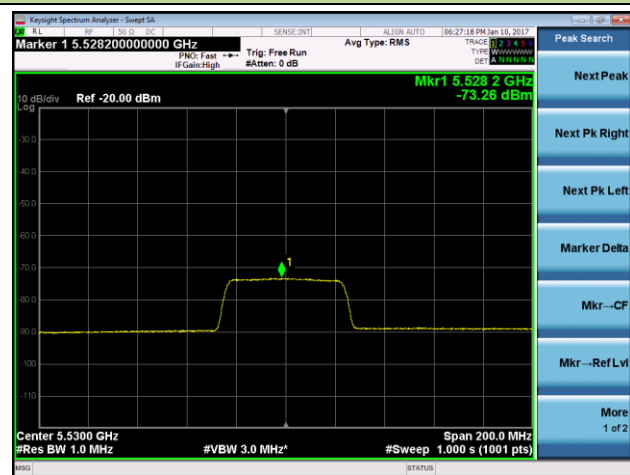
802.11ac-VHT80 – 5530MHz
Maximum Channel Occupancy Time = 612.6us
Minimum Idle Period = 65.70us

Interference Signal Calibration
Transmission stopped after interference added and the short control signaling less than 5ms.

Note: Detection Level = $-73 \text{ dBm/MHz} + (23 \text{ dBm} - \text{the max conducted power (dBm)})/\text{MHz} \geq -73 \text{ dBm/MHz}$ We used the worst-case detection level (-73dBm/MHz) to perform adaptivity testing.

Test Result:

Pass

11. User Access Restrictions

11.1. Requirement

DFS controls (hardware or software) related to radar detection shall not be accessible to the user so that the DFS requirements described in clauses 4.7.2.1 to 4.7.2.6 can neither be disabled nor altered.

11.2. Test Result

In the hardware, there is no switch or button to modify the DFS function or parameter for the user.
In the software, there is no options to modify the DFS function or parameter for the user.
The user access restrictions mechanism shall be implemented by the equipment which was declared by the manufacturer.

12. Measurement Uncertainty

Where relevant, the following measurement uncertainty levels have been estimated for tests performed on the apparatus:

Parameter	Uncertainty
Radio Frequency	$\pm 1 \times 10^{-5}$
RF Power Conducted	$\pm 1.5\text{dB}$
RF Power Radiated	$\pm 6\text{dB}$
Spurious Emissions, Conducted	$\pm 3\text{dB}$
Spurious Emissions, Radiated	$\pm 6\text{dB}$
Humidity	$\pm 5\%$
Temperature	$\pm 1^\circ\text{C}$
Time	$\pm 10\%$

13. List of Measuring Instrument

Carrier Frequencies - TR3

Instrument	Manufacturer	Type No.	Serial No.	Cali. Interval	Cali. Due Date
Spectrum Analyzer	Agilent	N9020A	MY52090106	1 year	2017/05/08
Programmable Temperature & Humidity Chamber	BAOYT	BYH-1500L	1309W043	1 year	2017/12/06
Temperature/Humidity Meter	Yuhuaze	HTC-2	N/A	1 year	2017/12/20

Occupied Channel Bandwidth - TR3

Instrument	Manufacturer	Type No.	Serial No.	Cali. Interval	Cali. Due Date
Spectrum Analyzer	Agilent	N9020A	MY52090106	1 year	2017/05/08
Temperature/Humidity Meter	Yuhuaze	HTC-2	N/A	1 year	2017/12/20

RF Output Power, Transmit Power Control (TPC) and Power Density - TR3

Instrument	Manufacturer	Type No.	Serial No.	Cali. Interval	Cali. Due Date
Power Meter	Agilent	U2021XA	MY53410005	1 year	2017/12/06
Programmable Temperature & Humidity Chamber	BAOYT	BYH-1500L	1309W043	1 year	2017/12/06
Temperature/Humidity Meter	Yuhuaze	HTC-2	N/A	1 year	2017/12/20

Transmitter Unwanted Emissions Within the 5GHz RLAN Bands - TR3

Instrument	Manufacturer	Type No.	Serial No.	Cali. Interval	Cali. Due Date
Spectrum Analyzer	Agilent	N9020A	MY52090106	1 year	2017/05/08
Temperature/Humidity Meter	Yuhuaze	HTC-2	N/A	1 year	2017/12/20

Transmitter Spurious Emissions and Receiver Spurious Emissions - AC2

Instrument	Manufacturer	Type No.	Serial No.	Cali. Interval	Cal. Due Date
Spectrum Analyzer	Agilent	N9020A	MY52090106	1 year	2017/05/08
Broadband Coaxial Pre-amplifier	Schwarzbeck	BBV 9718	302	1 year	2017/12/10
Pre-amplifier	Schwarzbeck	BBV 9721	9721-008	1 year	2017/04/16
TRILOG Antenna	Schwarzbeck	VULB9162	9162-047	1 year	2017/10/22
Broad-Band Horn Antenna	Schwarzbeck	BBHA9120D	9120D-1167	1 year	2017/11/19
Broadband Horn Antenna	Schwarzbeck	BBHA9170	BBHA9170549	1 year	2017/01/05
Digital Thermometer & Hygrometer	Minggao	ETH529	N/A	1 year	2017/11/30
Anechoic Chamber	RIKEN	Chamber-AC2	N/A	1 year	2017/05/10

Adaptivity (Channel Access Mechanism) - TR3

Instrument	Manufacturer	Type No.	Serial No.	Cali. Interval	Cali. Due Date
Spectrum Analyzer	Agilent	N9020A	MY52090106	1 year	2017/05/08
Vector Signal Generator	Agilent	E4438C	MY49872484	1 year	2017/12/06
Directional Coupler	Narda	4216-20	1395	1 year	2017/03/29
Power Splitter	Mini-Circuits	ZFRSC-123-S+	N/A	N/A	N/A
Temperature/Humidity Meter	Yuhuaze	HTC-2	N/A	1 year	2017/12/20

Software	Version	Function
e3	V8.3.5	EMI Test Software

————— The End —————